



Sorbonne Université

lip6 Laboratory

**Coriolis**

**User's Guide**

Jean-Paul Chaput  
[Jean-Paul.Chaput@lip6.fr](mailto:Jean-Paul.Chaput@lip6.fr)



This work is licensed under a  
Creative Commons Attribution-NonCommercial-ShareAlike 4.0 International License.  
Creative Commons License [creativecommons.org/licenses/by-nc-sa/4.0/](https://creativecommons.org/licenses/by-nc-sa/4.0/)

## Contents

<b>Abstract</b> . . . . .	<b>3</b>
<b>Credits &amp; License</b> . . . . .	<b>3</b>
<b>Complete Design Flow &amp; Examples</b> . . . . .	<b>4</b>
<b>Installation</b> . . . . .	<b>4</b>
Fixed Directory Tree . . . . .	5
Building Coriolis . . . . .	6
The actively developed branch. . . . .	6
Installing on REDHAT or compatible distributions . . . . .	6
Building a Debug Enabled Version . . . . .	8
Installing on DEBIAN 9, UBUNTU 18 or compatible distributions . . . . .	9
Additional Requirement under MACOS . . . . .	9
CORIORIS & Docker . . . . .	9
Packaging Coriolis . . . . .	10
Hooking up into ALLIANCE . . . . .	10
Setting up the Environment (coriolisEnv.py) . . . . .	10
<b>CGT - The Graphical Interface</b> . . . . .	<b>10</b>
Viewer & Tools . . . . .	12
STRATUS Netlist Capture . . . . .	12
The HURRICANE Data-Base . . . . .	12
Synthetizing and loading a design . . . . .	13
Etesian -- Placer . . . . .	13
Katana -- Global Router . . . . .	15
Katana -- Detailed Router . . . . .	15
Executing Python Scripts in Cgt . . . . .	17
Printing & Snapshots . . . . .	18
Memento of Shortcuts in Graphic Mode . . . . .	18
Cgt Command Line Options . . . . .	19
Miscellaneous Settings . . . . .	21
The Controller . . . . .	22
The Look Tab . . . . .	22
The Filter Tab . . . . .	23
The Layers&Go Tab . . . . .	24
The Netlist Tab . . . . .	24
The Selection Tab . . . . .	26
The Inspector Tab . . . . .	26
The Settings Tab . . . . .	29

## Abstract

Coriolis is a set of tools for vlsi backend. It's main features are :

- An analytic placer Etesian (based on Coloquinte).
- A router Katana for digital designs. An extension toward mixed design is currently under development.
- Python fast prototyping capabilities and layout procedural description.

Coriolis is a replacement of the Alliance place and route tools.

## Credits & License

Hurricane ..... Rémy Escassut & Christian Masson  
Etesian ..... Gabriel Gouvine  
Stratus ..... Sophie Belloeil  
Katana (global) ..... Damien Dupuis  
Katana (detailed), Unicorn ..... Jean-Paul Chaput

The Hurricane data-base is copyright© Bull 2000-2019 and is released under the terms of the lgpl license. All other tools are copyright© upmc 2008-2018, Sorbonne Université 2018-2019 and released under the gpl license.

Others important contributors to Coriolis are Christophe Alexandre, Roselyne Chotin, Hugo Clement, Marek Sroka and Wu Yifei.

The Katana router makes use of the Flute software, which is copyright© Chris C. N. Chu from the Iowa State University (<http://home.eng.iastate.edu/~cnchu/>).

## Complete Design Flow & Examples

While Coriolis can be used stand-alone, it is in fact part of a more complete design flow build upon Yosys and Alliance. In addition, a set of demos and examples are supplied in the repository `alliance-check-toolkit`.

- Yosys : <http://www.clifford.at/yosys/>  
An `rpm` packaged version is available here:  
[https://ftp.lip6.fr/pub/linux/distributions/slsoc/soc/7/addons/x86\\_64/repoview/yosys.html](https://ftp.lip6.fr/pub/linux/distributions/slsoc/soc/7/addons/x86_64/repoview/yosys.html)
- Alliance : <https://www-soc.lip6.fr/equipe-cian/logiciels/alliance/>
- `alliance-check-toolkit` `git` repository:  
<https://www-soc.lip6.fr/git/alliance-check-toolkit.git/>

## Installation



### Note

As the sources are being released, the binary packaging is dropped. You may still find (very) old versions here: <http://asim.lip6.fr/pub/coriolis/2.0>.

In a nutshell, building source consists in pulling the `git` repository then running the `ccb` installer.



### Note

The documentation is already generated and committed in the `git` tree. You may not install the additional prerequisites for the documentation. By default the documentation is not generated, just installed by `ccb`. If you really want to re-generate it, add the `--doc` flag to `ccb`.

Main building prerequisites:

- `cmake`
- C++11-capable compiler
- BFD library (provided through `binutils`).
- **RapidJSON**
- `python2.7`
- `boost`
- `libxml2`
- `bzip2`
- `yacc` & `lex`
- Qt 4 or Qt 5
- PyQt 4 or PyQt 5
- Qwt 6

Building documentation prerequisites:

- doxygen
- latex
- python-docutils (for reStructuredText)
- pelican

The following libraries get directly bundled with Coriolis:

- LEF/DEF (from [Si2](#))
- FLUTE (from [Chris C. N. Chu](#))

For other distributions, refer to their own packaging system.

## Fixed Directory Tree

In order to simplify the work of the **ccb** installer, the source, build and installation tree is fixed. To successfully compile Coriolis you must follow it exactly. The tree is relative to the home directory of the user building it (note `~/` or `$HOME/`). Only the source directory needs to be manually created by the user, all others will be automatically created either by **ccb** or the build system.

<b>Sources</b>	
Sources root <b>under git</b>	~/coriolis-2.x/src ~/coriolis-2.x/src/coriolis
<b>Architecture Dependant Build</b>	
Linux, SL 7, 64b	~/coriolis-2.x/Linux.el7_64/Release.Shared/build/<tool>
Linux, SL 6, 32b	~/coriolis-2.x/Linux.slsoc6x/Release.Shared/build/<tool>
Linux, SL 6, 64b	~/coriolis-2.x/Linux.slsoc6x_64/Release.Shared/build/<tool>
Linux, Fedora, 64b	~/coriolis-2.x/Linux.fc_64/Release.Shared/build/<tool>
Linux, Fedora, 32b	~/coriolis-2.x/Linux.fc/Release.Shared/build/<tool>
FreeBSD 8, 32b	~/coriolis-2.x/FreeBSD.8x.i386/Release.Shared/build/<tool>
FreeBSD 8, 64b	~/coriolis-2.x/FreeBSD.8x.amd64/Release.Shared/build/<tool>
Windows 7, 32b	~/coriolis-2.x/Cygwin.W7/Release.Shared/build/<tool>
Windows 7, 64b	~/coriolis-2.x/Cygwin.W7_64/Release.Shared/build/<tool>
Windows 8.x, 32b	~/coriolis-2.x/Cygwin.W8/Release.Shared/build/<tool>
Windows 8.x, 64b	~/coriolis-2.x/Cygwin.W8_64/Release.Shared/build/<tool>
<b>Architecture Dependant Install</b>	
Linux, SL 6, 32b	~/coriolis-2.x/Linux.slsoc6x/Release.Shared/install/
<b>FHS Compliant Structure under Install</b>	
Binaries	.../install/bin
Libraries (Python)	.../install/lib
Include by tool	.../install/include/coriolis2/<project>/<tool>
Configuration files	.../install/etc/coriolis2/
Doc, by tool	.../install/share/doc/coriolis2/en/html/<tool>

**Note**

*Alternate build types:* the `Release.Shared` means an optimized build with shared libraries. But there are also available `Static` instead of `Shared` and `Debug` instead of `Release` and any combination of them.

`Static` does not work because I don't know yet to mix statically linked binaries and Python modules (which must be dynamic).

## Building Coriolis

### The actively developed branch

The **devel\_anabatic** branch is now closed and we go back to a more classical scheme where **master** is the stable version and **devel** the development one.

The Coriolis `git` repository is <https://gitlab.lip6.fr/vlsi-cad/coriolis.git>

**Note**

Again, the **devel\_anabatic** branch is now closed. Please revert to **devel** or **master**.

**Note**

As it is now possible to mix PYQT widget with CORIOLIS ones, it is simpler for us to revert to QT 4 only. Our reference OS being RHEL 7, there is no compatible PYQT5 build compatible with their QT 5 version (we fall short of one minor, they provides QT 5.9 were we need at least QT 5.10).

**Note**

Under RHEL 7 or clones, they upgraded their version of QT 4 (from 4.6 to 4.8) so the *diagonal line* bug no longer occurs. So we can safely use the default system QT again.

### Installing on REDHAT or compatible distributions

1. Install or check that the required prerequisites are installed :

```
dummy@lepka:~> yum install -y git cmake bison flex gcc-c++ libstdc++-devel \
    binutils-devel \
    boost-devel boost-python boost-filesystem \
    boost-regex boost-wave \
    python-devel libxml2-devel bzip2-devel \
    qt-devel
```

The packages `qwt` and `qwt-devel` are not provided by any standard repository (like `epel`). You may download them from the [LIP6 Addons Repository](#) Then run:

```
dummy@lepka:~> yum localinstall -y qwt-6.1.2-4.fc23.x86_64.rpm \
    qwt-devel-6.1.2-4.fc23.x86_64.rpm # Qwt f
```

You may also install them directly (whithout an intermediate download):

```
dummy@lepka:~> yum install -y http://ftp.lip6.fr/pub/linux/distributions/slsoc
    http://ftp.lip6.fr/pub/linux/distributions/slsoc
```

2. Install the unpackaged prerequisites. Currently, only [RapidJSON](#).

```
dummy@lepka:~> mkdir -p ~/coriolis-2.x/src/support
dummy@lepka:support> cd ~/coriolis-2.x/src/support
dummy@lepka:support> git clone http://github.com/miloyip/rapidjson
```

### 3. Create the source directory and pull the **git** repository:

```
dummy@lepka:~> mkdir -p ~/coriolis-2.x/src
dummy@lepka:src> cd ~/coriolis-2.x/src
dummy@lepka:src> git clone https://gitlab.lip6.fr/vlsi-cad/coriolis.git
```

### 4. Build & install:

```
dummy@lepka:src> cd coriolis
dummy@lepka:coriolis> git checkout devel
dummy@lepka:coriolis> ./bootstrap/ccb.py --project=support \
--project=coriolis \
--make="-j4 install"
```



#### Note

Pre-generated documentation will get installed by the previous command. Only if you did made modifications to it you need to regenerate it with:

```
dummy@lepka:coriolis> ./bootstrap/ccb.py --project=support \
--project=coriolis \
--doc --make="-j1 install"
```

We need to perform a separate installation of the documentation because it does not support to be generated with a parallel build. So we compile & install in a first stage in `-j4` (or whatever) then we generate the documentation in `-j1`

Under `rhel6` or clones, you must build using the **devtoolset**, the version is to be given as argument:

```
dummy@lepka:coriolis> ./bootstrap/ccb.py --project=coriolis \
--devtoolset=8 --make="-j4 install"
```

If you want to use Qt 5 instead of Qt 4, modify the previous steps as follows:

- At **step 1**, do not install the qt 4 related development package (`qt4-devel`), but instead:

```
dummy@lepka:~> yum install -y qt5-qtbase-devel qt5-qtsvg-devel
```

The package `qwt-qt5-devel` and it's dependency `qwt-qt5` are not provided by any standard repository (like `epel`). You may download them from the [LIP6 Addons Repository](#) Then run:

```
dummy@lepka:~> yum localinstall -y qwt-qt5-6.1.2-4.fc23.x86_64.rpm \
qwt-qt5-devel-6.1.2-4.fc23.x86_64.rpm # Q
```

- At **step 4**, add a `--qt5` argument to the `ccb.py` command line.
- The Python scripts that make use of PyQt in `ctrlcore` and `cumulus` must be edited to import `PyQt5` instead of `PyQt4` (should find a way to automatically switch between the two of them).

The complete list of **ccb** functionalities can be accessed with the `--help` argument. It also may be run in graphical mode (`--gui`).

### Building a Debug Enabled Version

The `Release.Shared` default version of the Coriolis is built stripped of symbols and optimized so that it makes analysing a core dump after a crash difficult. In the (unlikely) case of a crash, you may want to build, alongside the optimized version, a debug one which allows forensic examination by **gdb** (or **valgrind** or whatever).

Run again `ccb.py`, adding the `--debug` argument:

```
dummy@lepka:coriolis> ./bootstrap/ccb.py --project=support \
--project=coriolis \
--make="-j4 install" --debug
```

As `cgt` is a Python script, the right command to run **gdb** is:

```
dummy@lepka:work> gdb python core.XXXX
```



## Installing on DEBIAN 9, UBUNTU 18 or compatible distributions

First, install or check that the required prerequisites are installed:

```
dummy@lepka:~> sudo apt-get install -y build-essential binutils-dev
git cmake bison flex gcc python-dev
libboost-all-dev libboost-python-dev
zlib1g-dev libxml2-dev rapidjson-dev libbz2-dev
```

To use with Qt 4:

```
dummy@lepka:~> sudo apt-get install -y qt4-dev-tools libqwt-dev python-qt4
```

To use with Qt 5:

```
dummy@lepka:~> sudo apt-get install -y qtbase5-dev libqt5svg5-dev libqwt-qt5-dev
python-pyqt5
```



### Note

**Do not install both versions of Qwt** (for Qt 4 and Qt 5), this will confuse the installer and end up with a non functional software (it uses the headers from one Qt and libraries from the other version).

Second step is to create the source directory and pull the **git** repository:

```
dummy@lepka:~> mkdir -p ~/coriolis-2.x/src
dummy@lepka:src> cd ~/coriolis-2.x/src
dummy@lepka:src> git clone https://gitlab.lip6.fr/vlsi-cad/coriolis.git
```

Third and final step, build & install:

```
dummy@lepka:src> cd coriolis
dummy@lepka:coriolis> git checkout devel
dummy@lepka:coriolis> ./bootstrap/ccb.py --project=coriolis \
--make="-j4 install"
```

## Additional Requirement under MacOS

Coriolis makes use of the **boost : :python** module, but the MacPorts **boost** seems unable to work with the Python bundled with MacOS. So you have to install both of them from MacPorts:

```
dummy@macos:~> port install boost +python27
dummy@macos:~> port select python python27
dummy@macos:-> export DYLD_FRAMEWORK_PATH=/opt/local/Library/Frameworks
```

The last two lines tell MacOS to use the Python from MacPorts and *not* from the system. Then proceed with the generic install instructions.

## CORIOLIS & Docker

Under `bootstrap/docker/` scripts and configuration files are provided that allow to rebuild Alliance and Coriolis and perform the regression tests of `alliance-check-toolkit`. You may have a look at the `Dockerfile.system` configuration file to see exactly how to setup a vanilla system to build Coriolis.

To run the docker tests, call the `dockerManage.sh` scripts with the relevant arguments:

```
ego@home:debian-9> ../../dockerManage.sh -bS # build both system & coriolis ima
ego@home:debian-9> ../../dockerManage.sh -r # compile & check coriolis.
ego@home:debian-9> ../../dockerManage.sh -C # clear the images.
```

## Packaging Coriolis

Packager should not use `ccb`, instead `bootstrap/Makefile.package` is provided to emulate a top-level `autotool` makefile. Just copy it in the root of the Coriolis git repository (`~/corriolis-2.x/src/co`) and build.

Slightly outdated packaging configuration files can also be found under `bootstrap/`:

- `bootstrap/coriolis2.spec.in` for **rpm** based distributions.
- `bootstrap/debian` for Debian based distributions.

## Hooking up into ALLIANCE

Coriolis relies on Alliance for the cell libraries. So after installing or packaging, you must configure it so that it can find those libraries.

The easiest way is to setup the Alliance environment (i.e. sourcing `.../etc/profile.d/alc_env.{sh,csh}`) **before** setting up Coriolis environment (see the next section). To understand how Coriolis find/setup Alliance you may have look to the *Alliance Helper*.

## Setting up the Environment (coriolisEnv.py)

To simplify the tedious task of configuring your environment, a helper is provided in the `bootstrap` source directory (also installed in the directory `.../install/etc/coriolis2/`):

```
~/coriolis-2.x/src/coriolis/bootstrap/coriolisEnv.py
```

Use it like this:

```
dummy@lepka:~> eval `~/coriolis-2.x/src/coriolis/bootstrap/coriolisEnv.py`
```



### Note

**Do not call that script in your environment initialisation.** When used under RHEL6 or clones, it needs to be run in the `devtoolset` environment. The script then launch a new shell, which may cause an infinite loop if it's called again in, say `~/ .bashrc`.  
Instead you may want to create an alias:

```
alias c2r='eval "`~/coriolis-2.x/src/coriolis/bootstrap/coriolisEnv.py`'
```

## CGT - The Graphical Interface

The Coriolis graphical interface is split up into two windows.

- The **Viewer**, with the following features:
  - Basic load/save capabilities.
  - Displays the current working cell. Could be empty if the design is not yet placed.
  - Executes Stratus Scripts.
  - Menu to run the tools (placement, routage).

Features are detailed in [Viewer & Tools](#).

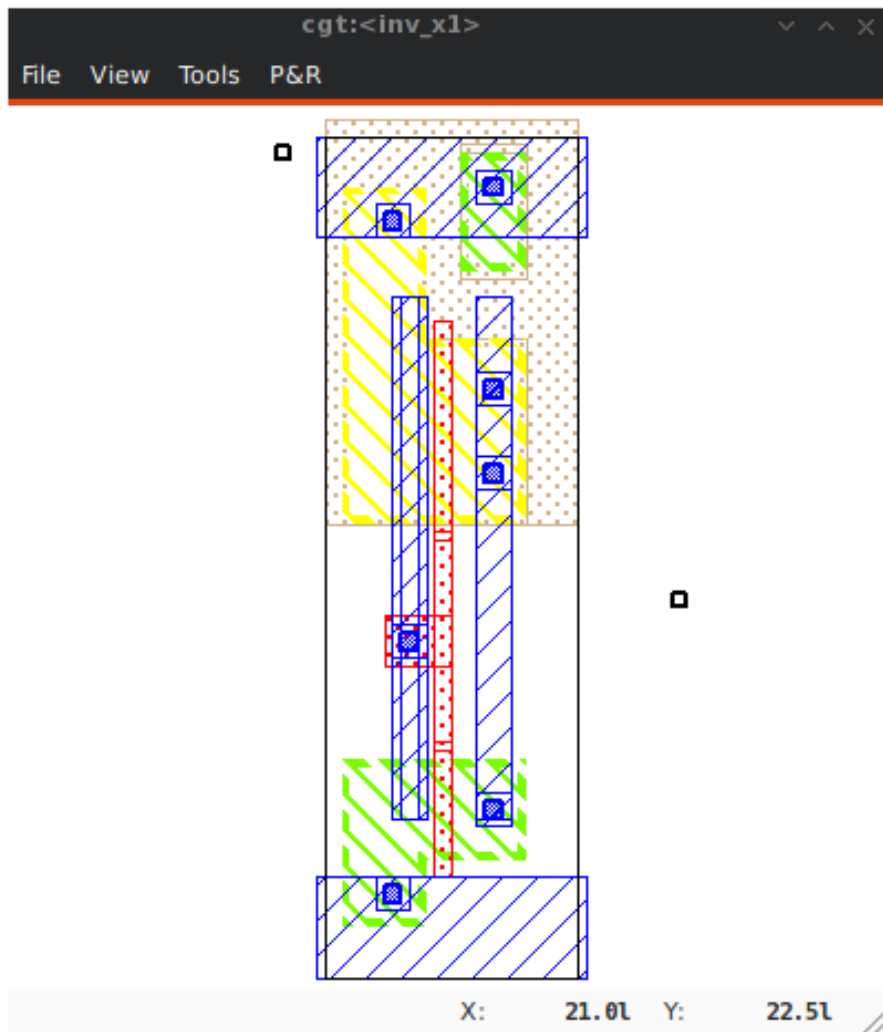

- The **Controller**, which allows to:
  - Tweak what is displayed by the *Viewer*. Through the *Look*, *Filter* and *Layers&Gos* tabs.
  - Browse the *netlist* with eponym tab.
  - Show the list of selected objects (if any) with *selection*
  - Walk through the Database, the Cell or the Selection with *Inspector*. This is an advanced feature, reserved for experimented users.
  - The tab *Settings* which gives access to all the settings. They are closely related to Configuration & Initialisation.

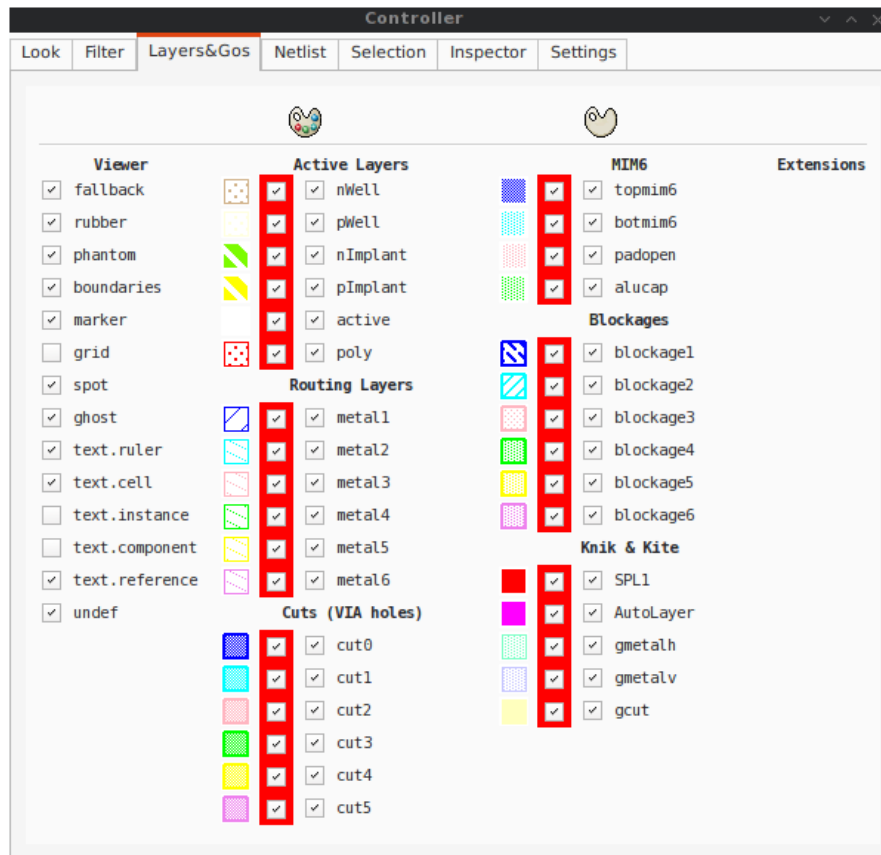

## Viewer & Tools

### STRATUS Netlist Capture

Stratus is the replacement for GenLib procedural netlist capture language. It is designed as a set of Python classes, and comes with it's own documentation ([Stratus Documentation](#))

### The HURRICANE Data-Base

The Alliance flow is based on the mbc data-base, which has one data-structure for each view. That is, **Lofig** for the *logical* view and **Phfig** for the *physical* view. The place and route tools were responsible for maintaining (or not) the coherency between views. Reflecting this weak coupling between views, each one was stored in a separate file with a specific format. The *logical* view is stored in a **vst** file in vhdl format and the *physical* in an **ap** file in an ad-hoc format.

The Coriolis flow is based on the Hurricane data-base, which has a unified structure for *logical* and *physical* view. That data structure is the *Cell* object. The *Cell* can have any state between pure netlist and completely placed and routed design. Although the memory representation of the views has deeply changed we still use the Alliance files format, but they now really represent views of the same object. The point is that one must be very careful about view coherency when going to and from Coriolis.

As for the second release, Coriolis can be used only for three purposes :

- **Placing a design**, in which case the *netlist* view must be present.
- **Routing a design**, in that case the *netlist* view and the *layout* view must be present and *layout* view must contain a placement. Both views must have the same name. When saving the routed design, it is advised to change the design name otherwise the original unrouted placement in the *layout* view will be overwritten.

- **Viewing a design**, the *netlist* view must be present, if a *layout* view is present it still must have the same name but it can be in any state.

### Synthetizing and loading a design

Coriolis supports several file formats. It can load all file format from the Alliance toolchain (.ap for layout, behavioural and structural vhd, .vbe and .vst), BLIF netlist format as well as benchmark formats from the ISPD contests.

It can be compiled with LEF/DEF support, although it requires acceptance of the SI2 license and may not be compiled in your version of the software.

**Synthesis under Yosys** You can create a BLIF file from the Yosys synthetizer, which can be imported under Coriolis. Most libraries are specified as a .lib liberty file and a .lef LEF file. Yosys opens most .lib files with minor modifications, but LEF support in Coriolis relies on SI2. If Coriolis hasn't been compiled against it, the library is given in Alliance .ap format. **Some free libraries** already provide both .ap and .lib files.

Once you have installed a common library under Yosys and Coriolis, just synthetize your design with Yosys and import it (as Blif without the extension) under Coriolis to perform place&route.

**Synthesis under Alliance** Alliance is an older toolchain but has been extensively used for years. Coriolis can import and write Alliance designs and libraries directly.

### Etesian -- Placer

The Etesian placer is a state of the art (as of 2015) analytical placer. It is within 5% of other placers' solutions, but is normally a bit worse than ePlace. This Coriolis tool is actually an encapsulation of Coloquinte which *is* the placer.



#### Note

*Instance Uniquification*: a same logical instance cannot have two different placements. So, if you don't supply a placement for it, it will be uniquified (cloned) and you will see the copy files appears on disk upon saving.

### Hierarchical Placement

The placement area is defined by the top cell abutment box.

When placing a complete hierarchy, the abutment boxes of the cells (models) other than the top cell are set identical to the one of the top cell and their instances are all placed at position (0, 0, ID). That is, all the abutments boxes, whatever the hierarchical level, define the same area (they are exactly superposed).

We choose this scheme because the placer will see all the instances as virtually flattened, so they can be placed anywhere inside the top-cell abutment box.

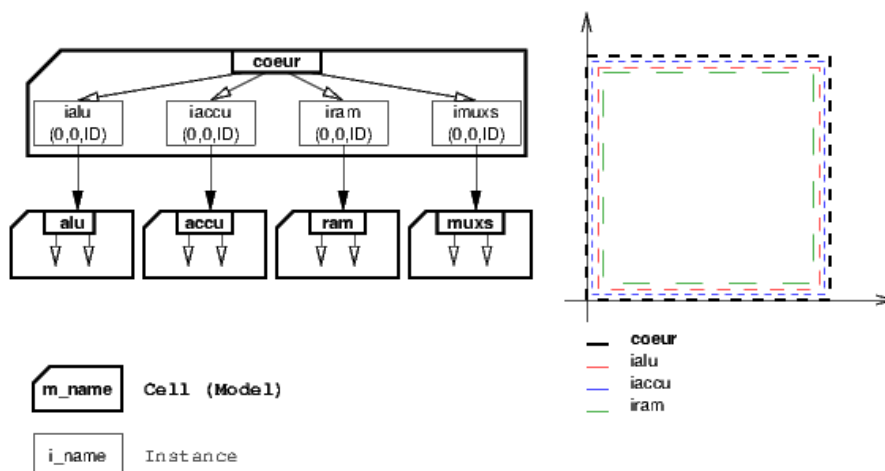

### Computing the Placement Area

The placement area is computed using the `etesian.aspectRatio` and `etesian.spaceMargin` parameters only if the top-cell has an empty abutment box. If the top-cell abutment box has to be set, then it is propagated to all the instances models recursively.

### Resetting the Placement

Once a placement has been done, the placer cannot reset it (will be implemented later). To perform a new placement, you must restart `cgt`. In addition, if you have saved the placement on disk, you must erase any `.ap` file, which are automatically reloaded along with the netlist (`.vst`).

### Limitations

Etesian supports standard cells and fixed macros. As for the Coriolis 2.1 version, it doesn't support movable macros, and you must place every macro beforehand. Timing and routability analysis are not included either, and the returned placement may be unroutable.

### Etesian Configuration Parameters

Parameter Identifier	Type	Default
<b>Etesian Parameters</b>		
<code>etesian.aspectRatio</code>	TypePercentage	<b>100</b>
	Define the height on width $H/W$ aspect ratio, can be comprised between 10 and 1000	
<code>etesian.spaceMargin</code>	TypePercentage	<b>5</b>
	The extra white space added to the total area of the standard cells	
<code>etesian.uniformDensity</code>	TypeBool	<b>False</b>
	Whether the cells will be spread evenly across the area or allowed to form denser clusters	
<code>etesian.effort</code>	TypeInt	<b>2</b>
	Sets the balance between the speed of the placer and the solution quality	
<code>etesian.routingDriven</code>	TypeBool	<b>False</b>
	Whether the tool will try routing iterations and whitespace allocation to improve routability; to be implemented	
<code>etesian.graphics</code>	TypeInt	<b>2</b>
	How often the display will be refreshed More refreshing slows the placer. <ul style="list-style-type: none"> <li>• 1 shows both upper and lower bounds</li> <li>• 2 only shows lower bound results</li> <li>• 3 only shows the final results</li> </ul>	

## Katana -- Global Router

The quality of Katana global routing solutions are equivalent to those of [FGR 1.0](#). For an in-depth description of Katana algorithms, you may download the thesis of D. Dupuis available from here-: [Knik Thesis](#) (Knik has been rewritten as part of Katana, the algorithms remains essentially the same).

The global router is now deterministic.

## Katana -- Detailed Router

Katana no longer suffers from the limitations of Nero. It can route big designs as its runtime and memory footprint is almost linear (with respect to the number of gates). It has successfully routed design of more than *150K* gates.



### Note

**Slow Layer Assignment.** Most of the time, the layer assignment stage is fast (less than a dozen seconds), but in some instances it can take more than a dozen *minutes*. This is a known bug and will be corrected in later releases.

After each run, Katana displays a set of *completion ratios* which must all be equal to *100%* or *(NNNN+0)* if the detailed routing has been successful. In the event of a failure, on a saturated design, you may tweak the three following configuration parameters:

1. `katana.hTrackReservedLocal`, the number of track reserved for local routing, that quantity is subtracted from the edge capacities (global routing) to give a sense of the cluttering inside the GCells.
2. `katana.vTrackReservedLocal`, same as above.
3. `etesian.spaceMargin`, increases the free area of the overall design so the routing density decrease.

The idea is to increase the horizontal and vertical local track reservation until the detailed router succeeds. But in doing so we make the task of the global router more and more difficult as the capacity of the edges decreases, and at some point it will fail too. So this is a balance.

Routing a design is done in four ordered steps:

1. Detailed pre-route **P&R** → **Step by Step** → **Detailed PreRoute**
2. Global routing **P&R** → **Step by Step** → **Global Route**
3. Detailed routing **P&R** → **Step by Step** → **Detailed Route**
4. Finalize routing **P&R** → **Step by Step** → **Finalize Route**

It is possible to supply to the router a complete wiring for some nets that the user wants to be routed according to a specific topology. The supplied topology must respect the building rules of the Anabatic database (contacts must be, *terminals*, *turns*, *h-tee* & *v-tee* only). During the first step `Detailed Pre-Route` the router will solve overlaps between the segments, without making any dogleg. If no pre-routed topologies are present, this step may be omitted. Any net routed at this step is then fixed and become unmovable for the later stages.

After the detailed routing step the Katana data-structure is still active (the Hurricane wiring is decorated). The finalize step performs the removal of the Katana data-structure, and it is not advisable to save the design before that step.

You may visualize the density (saturation) of either the edges (global routing) or the GCells (detailed routing) until the routing is finalized. Special layers appear to that effect in the [The Layers&Go Tab](#).

**Katana Configuration Parameters** The Anabatic parameters control the layer assignment step. All the defaults value given below are from the default Alliance technology (**cmos** and **SxLib** cell gauge/routing gauge).



Parameter Identifier	Type	Default
<b>Anabatic Parameters</b>		
anabatic.topRoutingLayer	TypeString	<b>METAL5</b>
	Define the highest metal layer that will be used for routing (inclusive).	
anabatic.globalLengthThreshold	TypeInt	<b>1450</b>
	This parameter is used by a layer assignment method which is no longer used (did not give good results)	
anabatic.saturateRatio	TypePercentage	<b>80</b>
	If $M(x)$ density is above this ratio, move up feedthru global segments up from depth $x$ to $x+2$	
anabatic.saturateRp	TypeInt	<b>8</b>
	If a GCell contains more terminals ( <b>RoutingPad</b> ) than that number, force a move up of the connecting segments to those in excess	
<b>Katana Parameters</b>		
katana.hTracksReservedLocal	TypeInt	<b>3</b>
	To take account the tracks needed <i>inside</i> a GCell to build the <i>local</i> routing, decrease the capacity of the edges of the global router. Horizontal and vertical locally reserved capacity can be distinguished for more accuracy.	
katana.vTracksReservedLocal	TypeInt	<b>3</b>
	cf. kite.hTracksReservedLocal	
katana.eventsLimit	TypeInt	<b>4000002</b>
	The maximum number of segment displacements, this is a last ditch safety against infinite loop. It's perhaps a little too low for big designs	
katana.ripupCost	TypeInt	<b>3</b>
	Differential introduced between two ripup costs to avoid a loop between two ripped up segments	
katana.strapRipupLimit	TypeInt	<b>16</b>
	Maximum number of ripup for <i>strap</i> segments	
katana.localRipupLimit	TypeInt	<b>9</b>
	Maximum number of ripup for <i>local</i> segments	
katana.globalRipupLimit	TypeInt	<b>5</b>
	Maximum number of ripup for <i>global</i> segments, when this limit is reached, triggers topologic modification	
katana.longGlobalRipupLimit	TypeInt	<b>5</b>
	Maximum number of ripup for <i>long global</i> segments, when this limit is reached, triggers topological modification	

### Executing Python Scripts in Cgt

Python/Stratus scripts can be executed either in text or graphical mode.

**Note**

**How Cgt Locates Python Scripts:** `cgt` uses the Python `import` mechanism to load Python scripts. So you must give the name of your script without `.py` extension and it must be reachable through the `PYTHONPATH`. You may use the dotted module notation.

A Python/Stratus script must contain a function called `scriptMain()` with one optional argument, the graphical editor into which it may be running (will be set to `None` in text mode). The Python interface to the editor (type: **CellViewer**) is limited to basic capabilities only.

Any script given on the command line will be run immediately *after* the initializations and *before* any other argument is processed.

For more explanation on Python scripts see *Python Interface to Coriolis*.

**Printing & Snapshots**

Printing or saving into a pdf is fairly simple, just use the **File -> Print** menu or the `CTRL+P` shortcut to open the dialog box.

The print functionality uses exactly the same rendering mechanism as for the screen, being almost *WYSIWYG*. Thus, to obtain the best results it is advisable to select the `Coriolis.Printer` look (in the *Controller*), which uses a white background and well suited for high resolutions 32x32 pixels patterns

There is also two modes of printing selectable through the *Controller Settings -> Misc -> Printer/Snapshot Mode*:

Mode	DPI (approx.)	Intended Usage
<b>Cell Mode</b>	150	For single <code>Cell</code> printing or very small designs. Patterns will be bigger and more readable.
<b>Design Mode</b>	300	For designs (mostly composed of wires and cells outlines).

**Note**

*The pdf file size* Be aware that the generated PDF files are indeed only pixmaps. So they can grow very large if you select paper format above A2 or similar.



Saving into an image is subject to the same remarks as for pdf.

**Memento of Shortcuts in Graphic Mode**

The main application binary is `cgt`.

Category	Keys	Action
<b>Moves</b>	<div style="display: flex; flex-wrap: wrap; gap: 5px;"> <div style="border: 1px solid black; padding: 2px;">Up</div> <div style="border: 1px solid black; padding: 2px;">Down</div> <div style="border: 1px solid black; padding: 2px;">Left</div> <div style="border: 1px solid black; padding: 2px;">Right</div> </div>	Shifts the view in the according direction
<b>Fit</b>	<code>f</code>	Fits to the Cell abutment box
<b>Refresh</b>	<code>CTRL+L</code>	Triggers a complete display redraw
<b>Goto</b>	<code>g</code>	<i>aperture</i> is the minimum side of the area displayed around the point to go to. It's an alternative way of setting the zoom level
<b>Zoom</b>	<code>z</code> , <code>m</code>	Respectively zoom by a 2 factor and <i>unzoom</i> by a 2 factor

... continued on next page

Category	Keys	Action
	 Area Zoom	You can perform a zoom to an area. Define the zoom area by <i>holding down the left mouse button</i> while moving the mouse.
Selection	 Area Selection	You can select displayed objects under an area. Define the selection area by <i>holding down the right mouse button</i> while moving the mouse.
	 Toggle Selection	You can toggle the selection of one object under the mouse position by pressing <code>CTRL</code> and pressing down <i>the right mouse button</i> . A popup list of what's under the position shows up into which you can toggle the selection state of one item.
	<code>S</code>	Toggle the selection visibility
Controller	<code>CTRL+I</code>	Show/hide the controller window. It's the Swiss Army Knife of the viewer. From it, you can fine-control the display and inspect almost everything in your design.
Rulers	<code>k</code> , <code>ESC</code>	One stroke on <code>k</code> enters the ruler mode, in which you can draw one ruler. You can exit the ruler mode by pressing <code>ESC</code> . Once in ruler mode, the first click on the <i>left mouse button</i> sets the ruler's starting point and the second click the ruler's end point. The second click exits automatically the ruler mode.
	<code>K</code>	Clears all the drawn rulers
Print	<code>CTRL+P</code>	Currently rather crude. It's a direct copy of what's displayed in pixels. So the resulting picture will be a little blurred due to anti-aliasing mechanism.
Open/Close	<code>CTRL+O</code>	Opens a new design. The design name must be given without path or extension.
	<code>CTRL+W</code>	Closes the current viewer window, but does not quit the application.
	<code>CTRL+Q</code>	<code>CTRL+Q</code> quits the application (closing all windows).
Hierarchy	<code>CTRL+Down</code>	Goes one hierarchy level down. That is, if there is an <i>instance</i> under the cursor position, loads its <i>model</i> Cell in place of the current one.
	<code>CTRL+Up</code>	Goes one hierarchy level up. If we have entered the current model through <code>CTRL+Down</code> reloads the previous model (the one in which this model is instanciated).

### Cgt Command Line Options

Appart from the obvious `--text` options, all can be used for text and graphical mode.

Arguments	Meaning
<code>-t --text</code>	Instructs <b>cgt</b> to run in text mode.

... continued on next page

Arguments	Meaning
<code>-L   --log-mode</code>	Disables the use of ansi escape sequence on the <code>tty</code> . Useful when the output is redirected to a file.
<code>-c &lt;cell&gt;   --cell=&lt;cell&gt;</code>	The name of the design to load, without leading path or extension.
<code>-m &lt;val&gt;   --margin=&lt;val&gt;</code>	Percentage <i>val</i> of white space for the placer (Etesian).
<code>--events-limit=&lt;count&gt;</code>	The maximal number of events after which the router will stop. This is mainly a failsafe against looping. The limit is set to 4 millions of iteration which should suffice to any design of <i>100K</i> . gates. For bigger designs you may want to increase this limit.
<code>-G   --global-route</code>	Runs the global router (Katana).
<code>-R   --detailed-route</code>	Runs the detailed router (Katana).
<code>-s   --save-design=&lt;routed&gt;</code>	The design into which the routed layout will be saved. It is strongly recommended to choose a different name from the source (unrouted) design.
<code>--stratus-script=&lt;module&gt;</code>	Run the Python/Stratus script <code>module</code> . See <a href="#">Python Scripts in Cgt</a> .

Some Examples :

- Run both global and detailed router, then save the routed design:

```
> cgt -v -t -G -R --cell=design --save-design=design_r
```

### Miscellaneous Settings

Parameter Identifier	Type	Default
<b>Verbosity/Log Parameters</b>		
misc.info	TypeBool	<b>False</b>
	Enables display of <i>info</i> level message ( <b>cinfo</b> stream)	
misc.bug	TypeBool	<b>False</b>
	Enables display of <i>bug</i> level message ( <b>cbug</b> stream), messages can be a little scary	
misc.logMode	TypeBool	<b>False</b>
	If enabled, assumes that the output device is not a <code>tty</code> and suppresses any escape sequences	
misc.verboseLevel1	TypeBool	<b>True</b>
	First level of verbosity, disables level 2	
misc.verboseLevel2	TypeBool	<b>False</b>
	Second level of verbosity	
<b>Development/Debug Parameters</b>		
misc.minTraceLevel	TypeInt	<b>0</b>
misc.maxTraceLevel	TypeInt	<b>0</b>
	Displays trace information <i>between</i> those two levels ( <b>cdebug</b> stream)	
misc.catchCore	TypeBool	<b>False</b>
	By default, <b>cgt</b> does not dump core. To generate one set this flag to <b>True</b>	

## The Controller

The *Controller* window is composed of seven tabs:

1. **The Look Tab** to select the display style.
2. **The Filter Tab** the hierarchical levels to be displayed, the look of rubbers and the dimension units.
3. **The Layers&Go Tab** to selectively hide/display layers.
4. **The Netlist Tab** to browse through the *netlist*. Works in association with the *Selection* tab.
5. **The Selection Tab** allows to view all the currently selected elements.
6. **The Inspector Tab** browses through either the DataBase, the Cell or the current selection.
7. **The Settings Tab** accesses all the tool's configuration settings.

### The Look Tab

You can select how the layout will be displayed. There is a special one `Printer.Coriolis` specifically designed for **Printing & Snapshots**. You should select it prior to calling the print or snapshot dialog boxes.

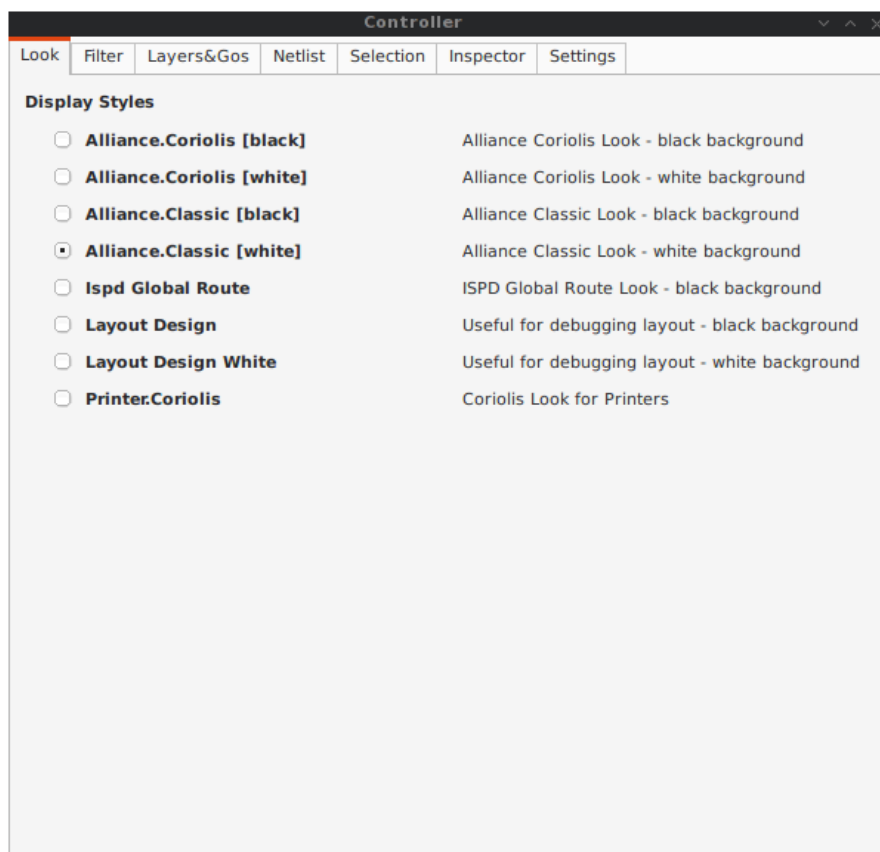

## The Filter Tab

The filter tab let you select what hierarchical levels of your design will be displayed. Hierarchy level are numbered top-down: the level 0 corresponds to the top-level cell, the level one to the instances of the top-level Cell and so on.

There are also check boxes to enable/disable the processing of Terminal Cell, Master Cells and Components. The processing of Terminal Cell (hierarchy leaf cells) is disabled by default when you load a hierarchical design and enabled when you load a single Cell.

You can choose what kind of form to give to the rubbers and the type of unit used to display coordinates.



### Note

*What are Rubbers:* HURRICANE uses *Rubbers* to materialize physical gaps in net topology. That is, if some wires are missing to connect two or more parts of net, a *rubber* will be drawn between them to signal the gap.

For example, after the detailed routing no *rubber* should remain. They have been made *very* visible as big violet lines...

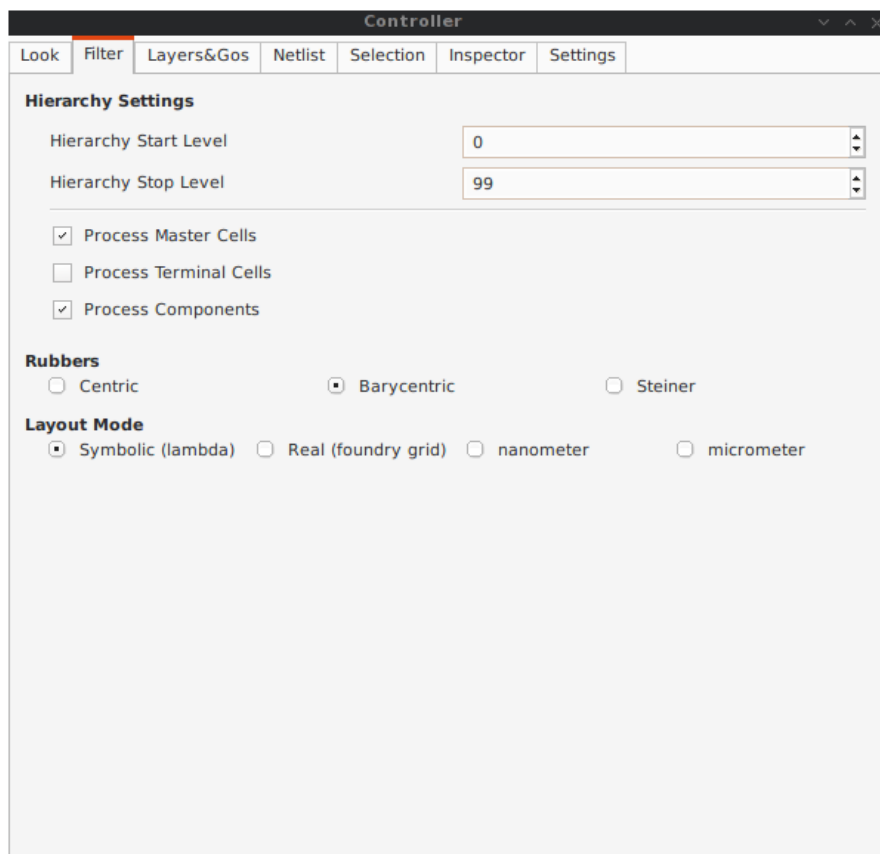

## The Layers&Go Tab

Control the individual display of all *layers* and *Gos*.

- *Layers* correspond to true physical layers. From a Hurricane point of view they are all the *BasicLayers* (could be matched to GDSII).
- *Gos* stands from *Graphical Objects*, they are drawings that have no physical existence but are added by the various tools to display extra information. One good exemple is the density map of the detailed router, to easily locate congested areas.

For each layer/Go there are two check boxes:

- The normal one triggers the display.
- The red-outlined allows objects of that layer to be selectable or not.

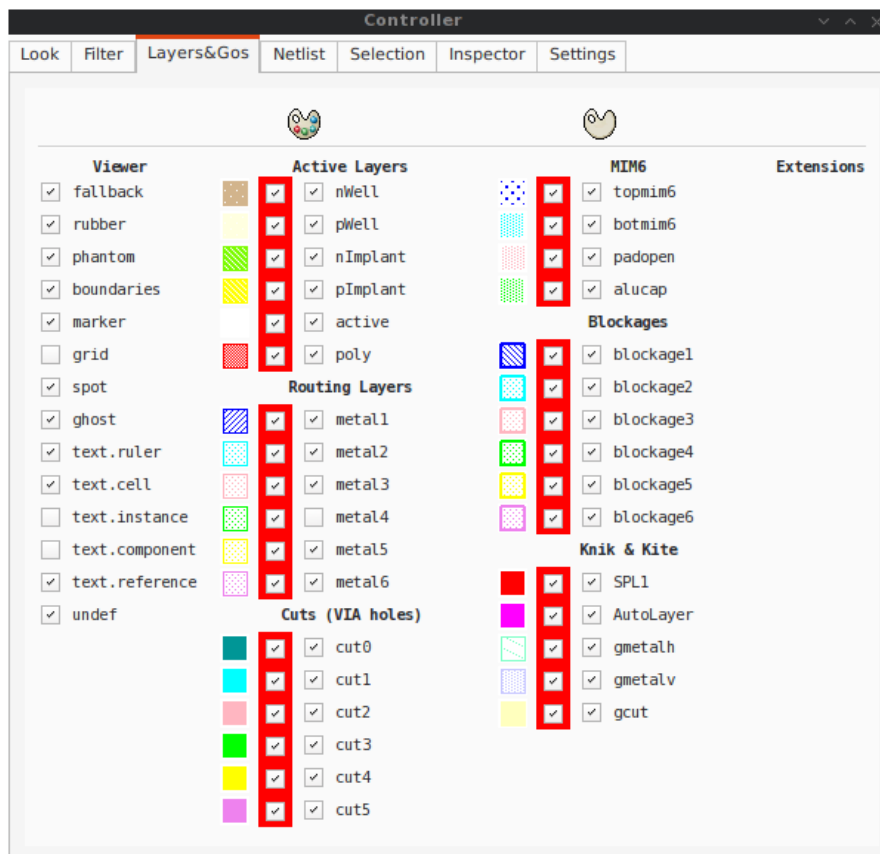

## The Netlist Tab

The *Netlist* tab shows the list of nets... By default the tab is not *synched* with the displayed Cell. To see the nets you must check the **Sync Netlist** checkbox. You can narrow the set of displayed nets by using the filter pattern (supports regular expressions).

A very useful feature is to enable the **Sync Selection**, which will automatically select all the components of the selected net(s). You can select multiple nets. In the figure the net `auxsc35` is selected and is highlighted in the *Viewer*.



Controller

Look Filter Layers&Gos **Netlist** Selection Inspector Settings

Sync Netlist  Sync Selection

Net	Plugs
a(0)	2
a(1)	1
a(2)	1
a(3)	1
auxreg1	2
auxreg2	2
auxreg3	3
auxreg4	4
auxsc1	8
auxsc11	2
auxsc16	3
auxsc18	3
auxsc20	4
auxsc21	4
auxsc22	4
auxsc24	3
<b>auxsc35</b>	<b>3</b>
auxsc36	2
auxsc37	2
auxsc38	2
auxsc39	5
auxsc40	2
auxsc41	4
auxsc43	2
auxsc44	2
auxsc45	2

Filter pattern:

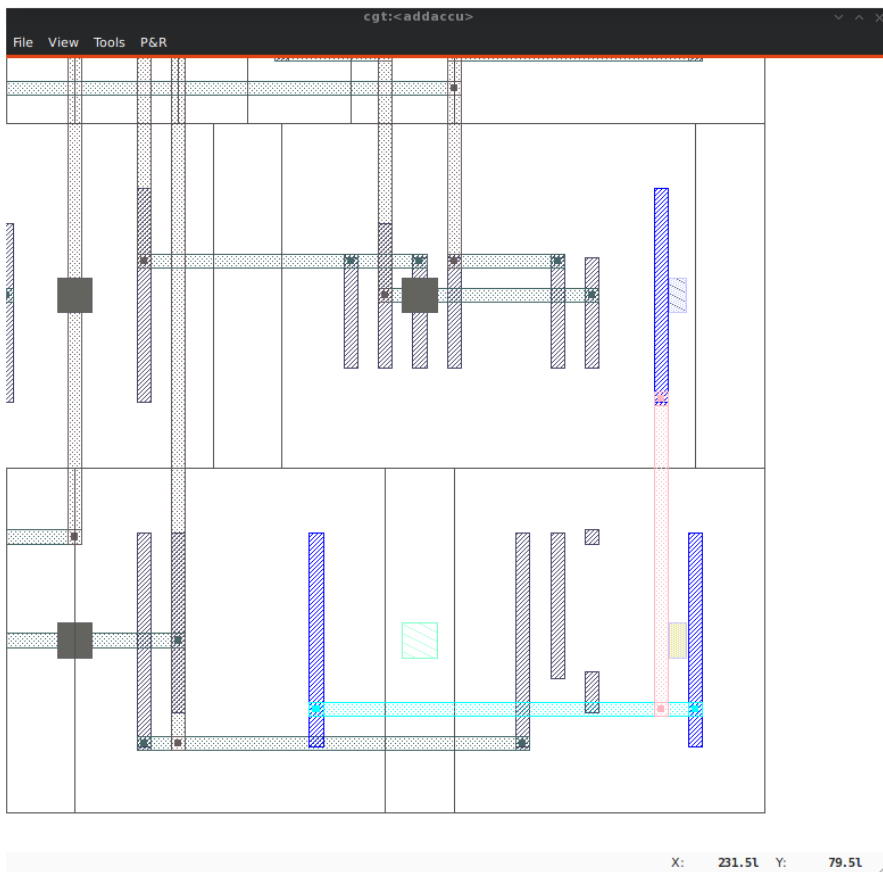

## The Selection Tab

The *Selection* tab lists all the components currently selected. They can be filtered thanks to the filter pattern.

Used in conjunction with the *Netlist Sync Selection* you will all see all the components part of *net*.

In this list, you can toggle individually the selection of component by pressing the `⌘` key. When unselected in this way a component is not removed from the the selection list but instead displayed in red italic. To see where a component is you may make it blink by repeatedly press the `⌘` key...

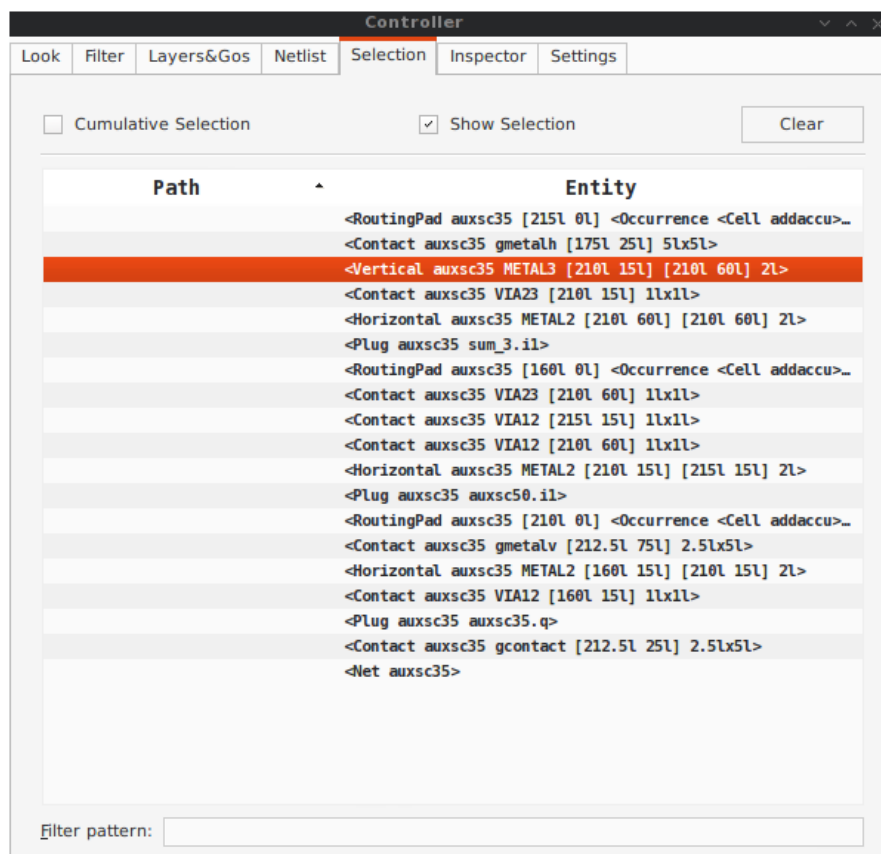

## The Inspector Tab

This tab is very useful, but mostly for Coriolis developpers. It allows to browse through the live DataBase. The *Inspector* provides three entry points:

- **DataBase:** Starts from the whole Hurricane DataBase.
- **Cell:** Inspects the currently loaded Cell.
- **Selection:** Inspects the object currently highlighted in the *Selection* tab.

Once an entry point has been activated, you may recursively expore all its fields using the right/left arrows.



### Note

*Do not put your fingers in the socket:* when inspecting anything, do not modify the DataBase. If any object under inspection is deleted, you will crash the application...

**Note**

*Implementation Detail:* the inspector support is done with Slot, Record and getString().

The screenshot shows the 'Controller' window with the 'Inspector' tab selected. The window title is 'Controller'. The menu bar includes 'Look', 'Filter', 'Layers&Gos', 'Netlist', 'Selection', 'Inspector', and 'Settings'. Below the menu bar is a dropdown menu with '<Selection>'. The main area displays a tree view with '0: <TopLevelSlot>' selected. Below this is a table with two columns: 'Object Attribute' and 'Value'. The table contains three rows: 'Entity' with value '<Vertical auxsc35 METAL3 [210l 15l] [210l 60l] 2l>', 'SharedPath' with value 'NULL [Hurricane::SharedPath]', and 'Quark' with value '<Quark <Occurrence <Cell addaccu>:<Vertical auxsc35 META...'. At the bottom, there is a 'Filter pattern:' label and an empty text input field.

Object Attribute	Value
Entity	<Vertical auxsc35 METAL3 [210l 15l] [210l 60l] 2l>
SharedPath	NULL [Hurricane::SharedPath]
Quark	<Quark <Occurrence <Cell addaccu>:<Vertical auxsc35 META...

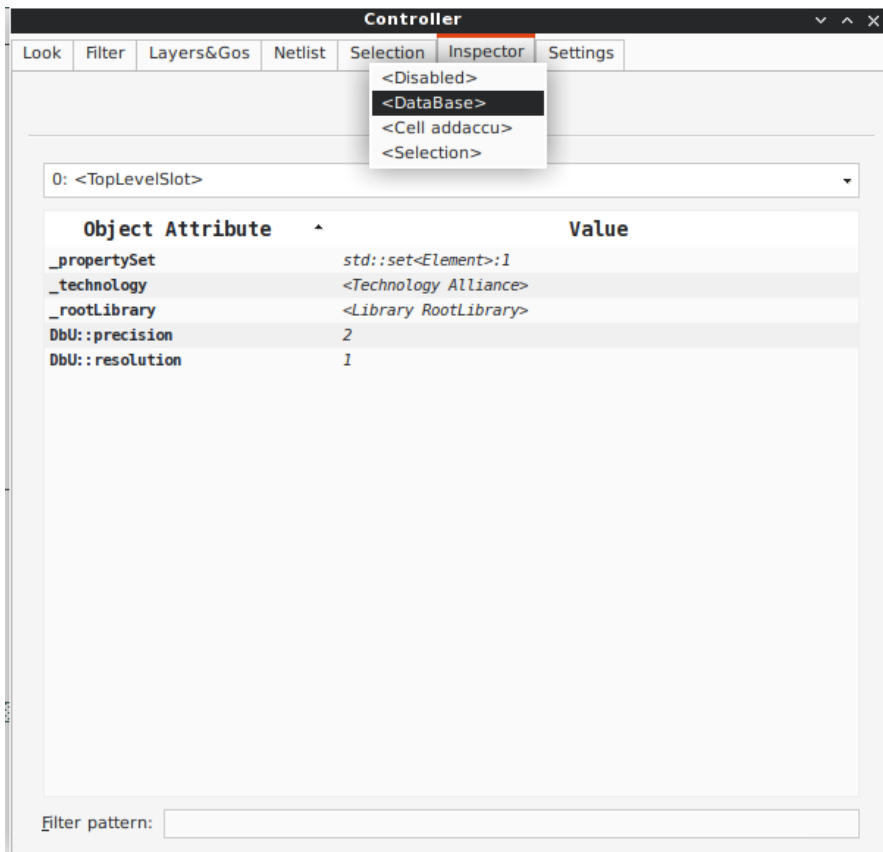
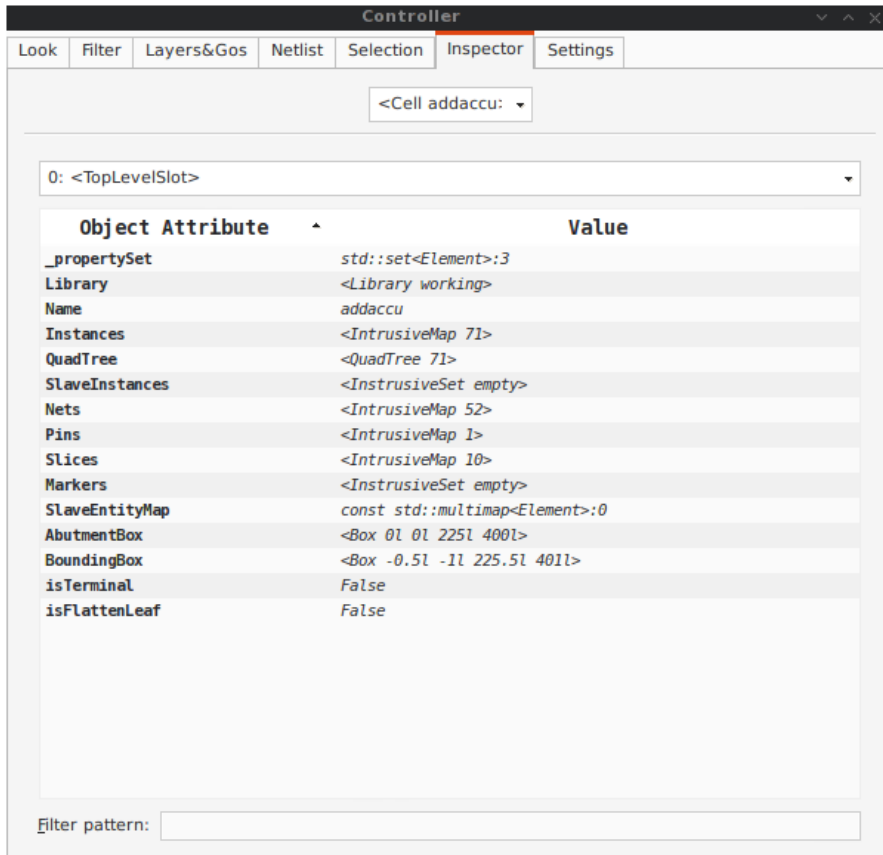

## The Settings Tab

Here comes the description of the *Settings* tab.

