

Coriolis User's Guide

Contents

Credits & License	2
Release Notes	2
Release 1.0.1475	2
Release 1.0.1963	2
Release 1.0.2049	3
Release v2.0.1	3
Release v2.1	3
Release v2.2	3
Installation	4
Fixed Directory Tree	5
Building Coriolis	6
Building the Devel Branch	6
Additional Requirement under MacOS	7
Packaging Coriolis	7
Hooking up into ALLIANCE	7
Setting up the Environment (coriolisEnv.py)	7
Coriolis Configuration & Initialisation	8
General Software Architecture	8
First Stage: Technology Selection	9
Second Stage: Technology Configuration Loading	9
Configuration Helpers	9
ALLIANCE Helper	10
Tools Configuration Helpers	11
Hacking the Configuration Files	13
CGT - The Graphical Interface	14
Viewer & Tools	15
STRATUS Netlist Capture	15
The HURRICANE Data-Base	15
Synthetizing and loading a design	16
Etesian -- Placer	16
Knik -- Global Router	18
Kite -- Detailed Router	18
Executing Python Scripts in Cgt	20
Printing & Snapshots	20
Memento of Shortcuts in Graphic Mode	20
Cgt Command Line Options	22
Miscellaneous Settings	23
The Controller	24
The Look Tab	24
The Filter Tab	25
The Layers&Go Tab	26
The Netlist Tab	26
The Selection Tab	28

The Inspector Tab	28
The Settings Tab	31
Python Interface for HURRICANE / CORIOLIS	31
Plugins	32
Chip Placement	32
Clock Tree	35
Recursive-Save (RSave)	36
A Simple Example: AM2901	36

Credits & License

HURRICANE Rémy ESCASSUT & Christian MASSON
ETESIAN Gabriel GOUVINE
STRATUS Sophie BELLOEIL
KNIK Damien DUPUIS
KITE , UNICORN Jean-Paul CHAPUT

The HURRICANE data-base is copyright© BULL 2000-2018 and is released under the terms of the LGPL license. All other tools are copyright© UPMC 2008-2018 and released under the GPL license.

Others important contributors to CORIOLIS are Christophe ALEXANDRE , Hugo CLEMENT , Marek SROKA and Wu YIFEI .

The KNIK router makes use of the FLUTE software, which is copyright© Chris C. N. CHU from the Iowa State University (<http://home.eng.iastate.edu/~cnchu/>).

Release Notes

Release 1.0.1475

This is the first preliminary release of the CORIOLIS 2 framework.

This release mainly ships the global router KNIK and the detailed router KITE . Together they aim to replace the ALLIANCE NERO router. Unlike NERO , KITE is based on an innovating routing modeling and ad-hoc algorithm. Although it is released under GPL license, the source code will be available later.

Contents of this release:

1. A graphical user interface (viewer only).
2. The KNIK global router.
3. The KITE detailed router.

Supported input/output formats:

- ALLIANCE **vst** (netlist) & **ap** (physical) formats.
- Even if there are some references to the CADENCE LEFDEF format, its support is not included because it depends on a library only available to SI2 affiliated members.

Release 1.0.1963

Release 1963 is alpha. All the tools from CORIOLIS 1 have been ported into this release.

Contents of this release:

1. The STRATUS netlist capture language (GENLIB replacement).
2. The MAUKA placer (still contains bugs).
3. A graphical user interface (viewer only).
4. The KNIK global router.
5. The KITE detailed router.
6. Partially implemented python support for configuration files (alternative to XML).
7. A documentation (imcomplete/obsoleted in HURRICANE 's case).

Release 1.0.2049

Release 2049 is Alpha.

Changes of this release:

1. The HURRICANE documentation is now accurate. Documentation for the Cell viewer and CRLCORE has been added.
2. More extensive Python support for all the components of CORIOLIS .
3. Configuration is now completely migrated under Python. XML loaders can still be used for compatibility.
4. The `cgt` main has been rewritten in Python.

Release v2.0.1

1. Migrated the repository from `svn` to `git` , and release complete sources. As a consequence, we drop the distribution packaging support and give public read-only access to the repository.
2. Deep rewrite of the KATABATIC database and KITE detailed router, achieve a speedup factor greater than 20...

Release v2.1

1. Replace the old simulated annealing placer MAUKA by the analytical placer ETESIAN and its legalization and detailed placement tools.
2. Added a Blif format parser to process circuits generated by the Yosys and ABC logic synthesizers.
3. The multiples user defined configuration files are now grouped under a common hidden (dot) directory `.coriolis2` and the file extension is back from `.conf` to `.py`.

Release v2.2

1. Added JSON import/export of the whole Hurricane DataBase. Two save mode are supported: *Cell* mode (standalone) or *Blob* mode, which dump the whole design down and including the standard cells.

Installation

**Note**

As the sources are being released, the binary packaging is dropped. You still may find older version here: <http://asim.lip6.fr/pub/coriolis/2.0>.

In a nutshell, building source consist in pulling the **git** repository then running the **ccb** installer.

Main building prerequisites:

- cmake
- C++11-capable compiler
- **RapidJSON**
- python2.7
- boost
- libxml2
- bzip2
- yacc & lex
- Qt 4 or Qt 5

Building documentation prerequisites:

- doxygen
- latex
- latex2html
- python-docutils (for reStructuredText)

Optional libraries:

- LEF/DEF (from **Sl2**)

For other distributions, refer to their own packaging system.

Fixed Directory Tree

In order to simplify the work of the **ccb** installer, the source, build and installation tree is fixed. To successfully compile CORIOLIS you must follow it exactly. The tree is relative to the home directory of the user building it (noted `~/` or `$HOME/`). Only the source directory needs to be manually created by the user, all others will be automatically created either by **ccb** or the build system.

Sources	
Sources root under git	~/coriolis-2.x/src ~/coriolis-2.x/src/coriolis
Architecture Dependant Build	
Linux, SL 7, 64b	~/coriolis-2.x/Linux.el7_64/Release.Shared/build/<tool>
Linux, SL 6, 32b	~/coriolis-2.x/Linux.slsoc6x/Release.Shared/build/<tool>
Linux, SL 6, 64b	~/coriolis-2.x/Linux.slsoc6x_64/Release.Shared/build/<tool>
Linux, Fedora, 64b	~/coriolis-2.x/Linux.fc_64/Release.Shared/build/<tool>
Linux, Fedora, 32b	~/coriolis-2.x/Linux.fc/Release.Shared/build/<tool>
FreeBSD 8, 32b	~/coriolis-2.x/FreeBSD.8x.i386/Release.Shared/build/<tool>
FreeBSD 8, 64b	~/coriolis-2.x/FreeBSD.8x.amd64/Release.Shared/build/<tool>
Windows 7, 32b	~/coriolis-2.x/Cygwin.W7/Release.Shared/build/<tool>
Windows 7, 64b	~/coriolis-2.x/Cygwin.W7_64/Release.Shared/build/<tool>
Windows 8.x, 32b	~/coriolis-2.x/Cygwin.W8/Release.Shared/build/<tool>
Windows 8.x, 64b	~/coriolis-2.x/Cygwin.W8_64/Release.Shared/build/<tool>
Architecture Dependant Install	
Linux, SL 6, 32b	~/coriolis-2.x/Linux.slsoc6x/Release.Shared/install/
FHS Compliant Structure under Install	
Binaries	.../install/bin
Libraries (Python)	.../install/lib
Include by tool	.../install/include/coriolis2/<project>/<tool>
Configuration files	.../install/etc/coriolis2/
Doc, by tool	.../install/share/doc/coriolis2/en/html/<tool>



Note

Alternate build types: the `Release.Shared` means an optimized build with shared libraries. But there are also available `Static` instead of `Shared` and `Debug` instead of `Release` and any combination of them.

`Static` do not work because I don't know yet to mix statically linked binaries and Python modules (which must be dynamic).

Building Coriolis

First step is to install the prerequisites. Currently, only **RapidJSON**. As RapidJSON is evolving fast, if you encounter compatibility problems, the exact version we compiled against is given below.

```
dummy@lepka:~> mkdir -p ~/coriolis-2.x/src/support
dummy@lepka:~> cd ~/coriolis-2.x/src/support
dummy@lepka:~> git clone http://github.com/miloyip/rapidjson
dummy@lepka:~> git checkout ec322005072076ef53984462fb4a1075c27c7dfd
```

The second step is to create the source directory and pull the **git** repository:

```
dummy@lepka:~> mkdir -p ~/coriolis-2.x/src
dummy@lepka:~> cd ~/coriolis-2.x/src
dummy@lepka:~> git clone https://www-soc.lip6.fr/git/coriolis.git
```

Third and final step, build & install:

```
dummy@lepka:src> ./bootstrap/ccb.py --project=support \
--project=coriolis \
--make="-j4 install"
dummy@lepka:src> ./bootstrap/ccb.py --project=support \
--project=coriolis \
--doc --make="-j1 install"
```

We need to separate to perform a separate installation of the documentation because it do not support to be generated with a parallel build. So we compile & install in a first stage in `-j4` (or whatever) then we generate the documentation in `-j1`

Under RHEL6 or clones, you must build using the **devtoolset2** :

```
dummy@lepka:src> ./bootstrap/ccb.py --project=coriolis \
--devtoolset-2 --make="-j4 install"
```

If you want to uses Qt 5 instead of Qt 4, you may add the `--qt5` argument.

The complete list of **ccb** functionalities can be accessed with the `--help` argument. It also may be run in graphical mode (`--gui`).

Building the Devel Branch

In the CORIOLIS **git** repository, two branches are present:

- The **master** branch, which contains the latest stable version. This is the one used by default if you follow the above instructions.
- The **devel** branch, which obviously contains the latest commits from the development team. To use it instead of the **master** one, do the following command just after the first step:

```
dummy@lepka:~> git checkout devel
dummy@lepka:src> ./bootstrap/ccb.py --project=coriolis \
--make="-j4 install" --debug
```

Be aware that it may requires newer versions of the dependencies and may introduce incompatibilites with the stable version.

In the (unlikely) event of a crash of **cg**t , as it is a PYTHON script, the right command to run **gdb** on it is:

```
dummy@lepka:work> gdb python core.XXXX
```

Additional Requirement under MacOS

CORIO LIS make uses of the **boost : :python** module, but the MACPORTS **boost** seems unable to work with the PYTHON bundled with MacOS . So you have to install both of them from MACPORTS :

```
dummy@macos:~> port install boost +python27
dummy@macos:~> port select python python27
dummy@macos:-> export DYLD_FRAMEWORK_PATH=/opt/local/Library/Frameworks
```

The last two lines tell MacOS to use the PYTHON from MACPORTS and *not* from the system. Then proceed with the generic install instructions.

Packaging Coriolis

Packager should not uses **ccb** , instead `bootstrap/Makefile.package` is provided to emulate a top-level `autotool` makefile. Just copy it in the root of the CORIO LIS git repository (`~/corriolis-2.x/src/coriolis/`) and build.

Slightly outdated packaging configuration files can also be found under `bootstrap/`:

- `bootstrap/coriolis2.spec.in` for **rpm** based distributions.
- `bootstrap/debian` for DEBIAN based distributions.

Hooking up into ALLIANCE

CORIO LIS relies on ALLIANCE for the cell libraries. So after installing or packaging, you must configure it so that it can found those libraries.

The easiest way is to setup the ALLIANCE environment (i.e. sourcing `.../etc/profile.d/alc_env.{sh,csh}`) **before** setting up CORIO LIS environment (see the next section). To understand how CORIO LIS find/setup ALLIANCE you may have look to the [Alliance Helper](#).

Setting up the Environment (coriolisEnv.py)

To simplify the tedious task of configuring your environment, a helper is provided in the `bootstrap` source directory (also installed in the directory `.../install/etc/coriolis2/`):

```
~/corriolis-2.x/src/coriolis/bootstrap/coriolisEnv.py
```

Use it like this:

```
dummy@lepka:~> eval `~/corriolis-2.x/src/coriolis/bootstrap/coriolisEnv.py`
```



Note

Do not call that script in your environment initialisation. When used under RHEL6 or clones, it needs to be run in the **devtoolset2** environment. The script then launch a new shell, which may cause an infinite loop if it's called again in, say `~/ .bashrc` .

Instead you may want to create an alias:

```
alias c2r='eval "`~/corriolis-2.x/src/coriolis/bootstrap/coriolisEnv.py`'
```

Coriolis Configuration & Initialisation

General Software Architecture

CORIORIS has been build with respect of the classical paradigm that the computational instensive parts have been written in C++, and almost everything else in PYTHON . To build the PYTHON interface we used two methods:

- For self-contained modules `boost : :python` (mainly in `v1sisapd`).
- For all modules based on HURRICANE , we created our own wrappers due to very specific requirements such as shared functions between modules or C++/PYTHON secure bi-directional object deletion.



Note

Python Documentation: Most of the documentation is related to the C++ API and implemetation of the tools. However, the PYTHON bindings have been created so they mimic *as closely as possible* the C++ interface, so the documentation applies to both languages with only minor syntactic changes.

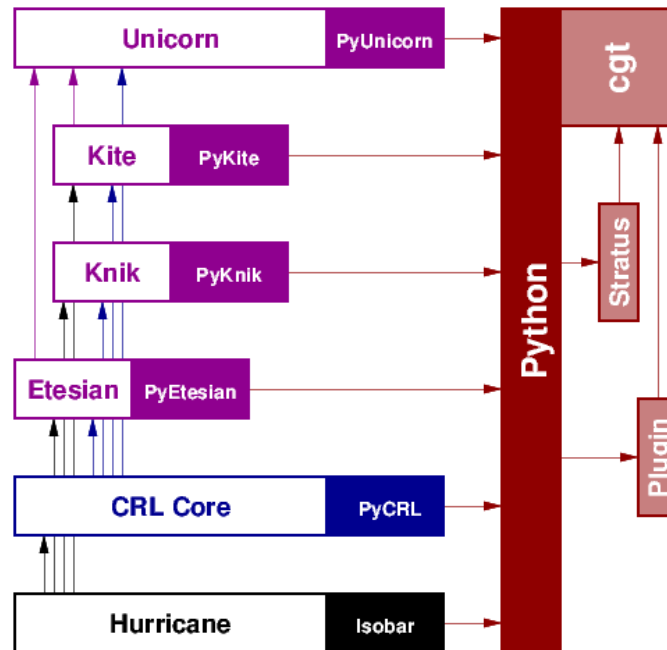

All configuration & initialization files are Python scripts, despite their `.conf` extention. From a syntactic point of view, there is no difference between the system-wide configuration files and the user's configuration, they use the same Python helpers.

Configuration is done in two stages:

1. Selecting the technology.
2. Loading the complete configuration for the given technology and the user's settings.

First Stage: Technology Selection

The initialization process is done by executing, in order, the following file(s):

Order	Meaning	File
1	The system setting	<code>/etc/coriolis2/techno.conf</code>
2	The user's global setting	<code>\${HOME}/.coriolis2/techno.py</code>
3	The user's local setting	<code><CWD>/.coriolis2/techno.py</code>

Thoses files must provides only one variable, the name of the technology. Each technology will provide configuration for both the symbolic part and the real part. CORIOLIS can work with purely symbolic technology (`symbolic/cmos`) in that case, the real technology part is a dummy one.

For example, to use MOSIS 180nm:

```
# -*- Mode:Python -*-

technology = '180/scn6m_deep_09'
```

Second Stage: Technology Configuration Loading

The `technology` variable is set by the first stage and it's the name of the technology. A directory of that name, with all the configuration files, must exists in the configuration directory (`/etc/coriolis2`). In addition to the technology-specific directories, a `common/` directory is there to provides a trunk for all the identical datas across the various technologies. The initialization process is done by executing, in order, the following file(s):

Order	Meaning	File
1	The system initialization	<code>/etc/coriolis2/<technology>/<TOOL>.conf</code>
2	The user's global initialization	<code>\${HOME}/.coriolis2/settings.py</code>
3	The user's local initialization	<code><CWD>/.coriolis2/settings.py</code>

Note

The loading policy is not hard-coded. It is implemented at Python level in `/etc/coriolis2/coriolisInit.py`, and thus may be easily amended to whatever site policy.

The truly mandatory requirement is the existence of `coriolisInit.py` which *must* contain a `coriolisConfigure()` function with no argument.

The `coriolisInit.py` script execution is triggered by the `import` of the `CRL` module:

```
import sys
import os.path
import Cfg
import Hurricane
import CRL          # Triggers execution of "coriolisInit.py".
import Viewer
```



Configuration Helpers

To ease the writing of configuration files, a set of small helpers is available. They allow to setup the configuration parameters through simple assembly of tuples. The helpers are installed under the directory:

```
<install>/etc/coriolis2/
```

Where `<install>/` is the root of the installation.

ALLIANCE Helper

The configuration file must provide an `allianceConfig` tuple as shown below. Like all the CORIOLIS configuration file, it is to be executed through PYTHON, so we can use it to perform a not so dumb search of the ALLIANCE installation directory. Our default policy is to try to read the `ALLIANCE_TOP` environment variable, and if not found, default to `/soc/alliance`.

```
import os
from helpers.Alliance import AddMode
from helpers.Alliance import Gauge

allianceTop = None
if os.environ.has_key('ALLIANCE_TOP'):
    allianceTop = os.environ['ALLIANCE_TOP']
    if not os.path.isdir(allianceTop):
        allianceTop = None

if not allianceTop: allianceTop = '/soc/alliance'

cellsTop = allianceTop+'/'

allianceConfig = \
    ( ( 'CATALOG'           , 'CATAL' )
      , ( 'WORKING_LIBRARY' , '.' )
      , ( 'SYSTEM_LIBRARY'  , ( (cellsTop+'sxlib'   , AddMode.Append)
                               , (cellsTop+'dp_sxlib'  , AddMode.Append)
                               , (cellsTop+'ramlib'    , AddMode.Append)
                               , (cellsTop+'romlib'    , AddMode.Append)
                               , (cellsTop+'rflib'     , AddMode.Append)
                               , (cellsTop+'rf2lib'    , AddMode.Append)
                               , (cellsTop+'pxlib'     , AddMode.Append)
                               , (cellsTop+'padlib'    , AddMode.Append) ) )
      , ( 'IN_LO'          , 'vst' )
      , ( 'IN_PH'          , 'ap' )
      , ( 'OUT_LO'         , 'vst' )
      , ( 'OUT_PH'         , 'ap' )
      , ( 'POWER'          , 'vdd' )
      , ( 'GROUND'         , 'vss' )
      , ( 'CLOCK'           , '.*ck.*|.*nck.*' )
      , ( 'BLOCKAGE'       , '^blockage[Nn]et*' )
      , ( 'PAD'             , '.*_px$' )
    )
```

The example above shows the system configuration file, with all the available settings. Some important remarks about those settings:

- In its configuration file, the user do not need to redefine all the settings, just the one he wants to change. In most of the cases, the `SYSTEM_LIBRARY`, the `WORKING_LIBRARY` and the special net names (at this point there is not much alternatives for the others settings).
- `SYSTEM_LIBRARY` setting: Setting up the library search path. Each library entry in the tuple will be added to the search path according to the second parameter:
 - **AddMode::Append** : append to the search path.
 - **AddMode::Prepend** : insert in head of the search path.
 - **AddMode::Replace** : look for a library of the same name and replace it, without changing the search path order. If no library of that name already exists, it is appended.

A library is identified by its name, this name is the last component of the path name. For instance: `/soc/alliance/sxlib` will be named `sxlib`. Implementing the ALLIANCE specification, when looking for a *Cell* name, the system will browse sequentially through the library list and returns the first *Cell* whose name match.

- For POWER, GROUND, CLOCK and BLOCKAGE net names, a regular expression (GNU regexp) is expected.

A typical user's configuration file would be:

```
import os

homeDir = os.getenv('HOME')

allianceConfig = \
    ( ('WORKING_LIBRARY'      , homeDir+'/worklib')
    , ('SYSTEM_LIBRARY'      , ( (homeDir+'/mylib', Environment.Append) ) )
    , ('POWER'                , 'vdd.*')
    , ('GROUND'               , 'vss.*')
    )
```

Tools Configuration Helpers

All the tools use the same helper to load their configuration (a.k.a. *Configuration Helper*). Currently the following configuration system-wide configuration files are defined:

- **misc.conf** : commons settings or not belonging specifically to a tool.
- **etesian.conf** : for the ETESIAN tool.
- **kite.conf** : for the KITE tool.
- **stratus1.conf** : for the STRATUS1 tool.

Here is the contents of **etesian.conf** :

```
# Etesian parameters.
parametersTable = \
    ( ('etesian.aspectRatio'      , TypePercentage, 100      , { 'min':10, 'max':1000 } )
    , ('etesian.spaceMargin'      , TypePercentage, 5          )
    , ('etesian.uniformDensity'   , TypeBool      , False     )
    , ('etesian.routingDriven'    , TypeBool      , False     )
    , ("etesian.effort"           , TypeEnumerate , 2
    , { 'values':( ("Fast"        , 1)
                  , ("Standard"  , 2)
                  , ("High"       , 3)
                  , ("Extreme"    , 4) ) }
    )
    , ("etesian.graphics"         , TypeEnumerate , 2
    , { 'values':( ("Show every step" , 1)
                  , ("Show lower bound" , 2)
                  , ("Show result only" , 3) ) }
    )
    )

layoutTable = \
    ( (TypeTab      , 'Etesian', 'etesian')

    , (TypeTitle   , 'Placement area')
    , (TypeOption  , "etesian.aspectRatio"      , "Aspect Ratio, X/Y (%)", 0 )
    , (TypeOption  , "etesian.spaceMargin"          , "Space Margin"          , 1 )
    , (TypeRule    , )
```

```
, (TypeTitle , 'Etesian - Placer')
, (TypeOption, "etesian.uniformDensity", "Uniform density"      , 0 )
, (TypeOption, "etesian.routingDriven" , "Routing driven"      , 0 )
, (TypeOption, "etesian.effort"        , "Placement effort"   , 1 )
, (TypeOption, "etesian.graphics"      , "Placement view"     , 1 )
, (TypeRule ,)
)
```

Taxonomy of the file:

- It must contains, at least, the two tables:
 - `parametersTable`, defines & initialise the configuration variables.
 - `layoutTables`, defines how the various parameters will be displayed in the configuration window ([The Settings Tab](#)).
- The `parametersTable`, is a tuple (list) of tuples. Each entry in the list describe a configuration parameter. In it's simplest form, it's a quadruplet (**TypeOption**, **'paramId'**, **ParameterType**, **DefaultValue**) with:
 1. `TypeOption`, tells that this tuple describe a parameter.
 2. `paramId`, the identifier of the parameter. Identifiers are defined by the tools. The list of parameters is detailed in each tool section.
 3. `ParameterType`, the kind of parameter. Could be:
 - `TypeBool`, boolean.
 - `TypeInt`, signed integer.
 - `TypeEnumerate`, enumerated type, needs extra entry.
 - `TypePercentage`, percentage, expressed between 0 and 100.
 - `TypeDouble`, float.
 - `TypeString`, character string.
 4. `DefaultValue`, the default value for that parameter.

Hacking the Configuration Files

Asides from the symbols that gets used by the configuration helpers like `allianceConfig` or `parametersTable`, you can put pretty much anything in `<CWD>/coriolis2/settings.py` (that is, written in PYTHON).

For example:

```
# -*- Mode:Python -*-

defaultStyle = 'Alliance.Classic [black]'

# Regular Coriolis configuration.
parametersTable = \
( ('misc.catchCore'           , TypeBool      , False )
  , ('misc.info'              , TypeBool      , False )
  , ('misc.paranoid'          , TypeBool      , False )
  , ('misc.bug'               , TypeBool      , False )
  , ('misc.logMode'           , TypeBool      , True  )
  , ('misc.verboseLevel1'    , TypeBool      , False )
  , ('misc.verboseLevel2'    , TypeBool      , True  )
  , ('misc.minTraceLevel'    , TypeInt       , 0    )
  , ('misc.maxTraceLevel'    , TypeInt       , 0    )
)

# Some ordinary Python script...
import os

print '      o Cleaning up ClockTree previous run.'
for fileName in os.listdir('.'):
    if fileName.endswith('.ap') or (fileName.find('_clocked.') >= 0):
        print '      - <%s>' % fileName
        os.unlink(fileName)
```

See [Python Interface to Coriolis](#) for more details those capabilities.

CGT - The Graphical Interface

The CORIOLIS graphical interface is split up into two windows.

- The **Viewer**, with the following features:
 - Basic load/save capabilities.
 - Display the current working cell. Could be empty if the design is not yet placed.
 - Execute Stratus Scripts.
 - Menu to run the tools (placement, routage).

Features are detailed in [Viewer & Tools](#).

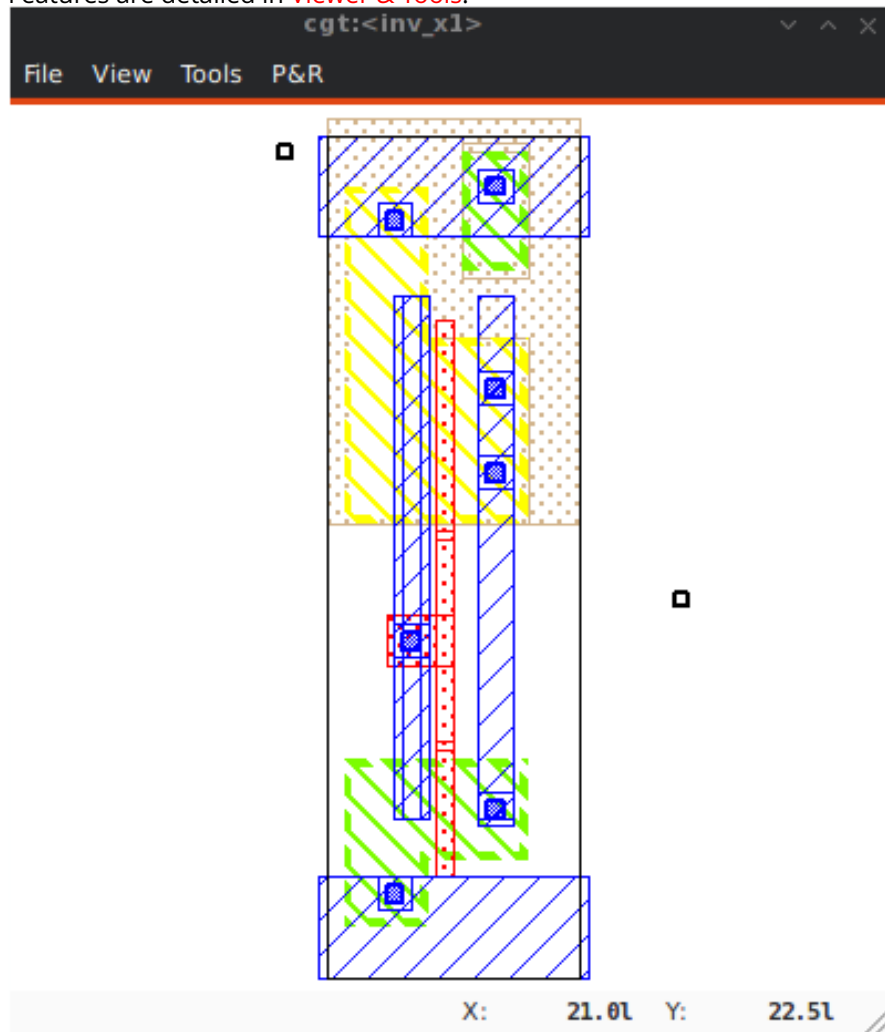

- The **Controller**, which allows:
 - Tweak what is displayed by the *Viewer*. Through the *Look*, *Filter* and *Layers&Gos* tabs.
 - Browse the *netlist* with eponym tab.
 - Show the list of selected objects (if any) with *selection*
 - Walk through the Database, the Cell or the Selection with *Inspector*. This is an advanced feature, reserved for experimented users.
 - The tab *Settings* which give access to all the settings. They are closely related to Configuration & Initialisation.

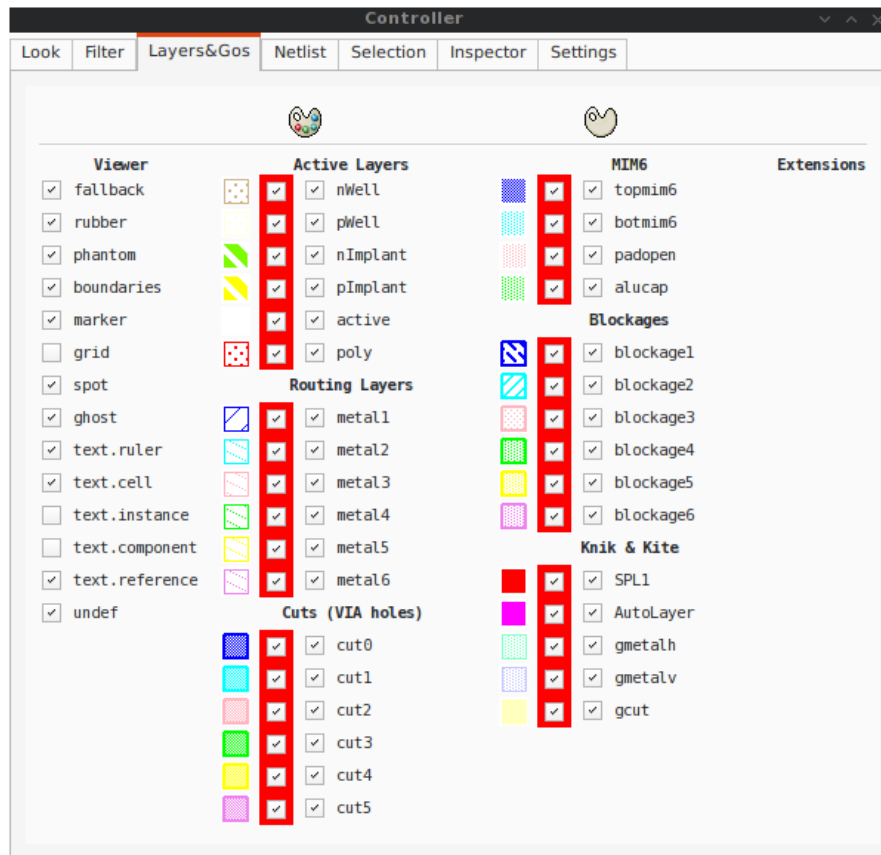

Viewer & Tools

STRATUS Netlist Capture

STRATUS is the replacement for GENLIB procedural netlist capture language. It is designed as a set of PYTHON classes, and comes with it's own documentation ([Stratus Documentation](#))

The HURRICANE Data-Base

The ALLIANCE flow is based on the MBK data-base, which has one data-structure for each view. That is, **Lofig** for the *logical* view and **Phfig** for the *physical* view. The place and route tools were responsible for maintaining (or not) the coherency between views. Reflecting this weak coupling between views, each one was stored in a separate file with a specific format. The *logical* view is stored in a **vst** file in VHDL format and the *physical* in an **ap** file in an ad-hoc format.

The CORIOLIS flow is based on the HURRICANE data-base, which has a unified structure for *logical* and *physical* view. That data structure is the *Cell* object. The *Cell* can have any state between pure netlist and completely placed and routed design. Although the memory representation of the views has deeply changed we still use the ALLIANCE files format, but they now really represent views of the same object. The point is that one must be very careful about view coherency when going to and from CORIOLIS .

As for the second release, CORIOLIS can be used only for three purposes :

- **Placing a design**, in which case the *netlist* view must be present.
- **Routing a design**, in that case the *netlist* view and the *layout* view must be present and *layout* view must contain a placement. Both views must have the same name. When saving the routed design, it is advised to change the design name otherwise the original unrouted placement in the *layout* view will be overwritten.

- **Viewing a design**, the *netlist* view must be present, if a *layout* view is present it still must have the same name but it can be in any state.

Synthesizing and loading a design

COROLIS supports several file formats. It can load all file format from the ALLIANCE toolchain (.ap for layout, behavioural and structural vhdl .vbe and .vst), BLIF netlist format as well as benchmark formats from the ISPD contests.

It can be compiled with LEF/DEF support, although it requires acceptance of the SI2 license and may not be compiled in your version of the software.

Synthesis under Yosys You can create a BLIF file from the Yosys synthesizer, which can be imported under Coriolis. Most libraries are specified as a .lib liberty file and a .lef LEF file. Yosys opens most .lib files with minor modifications, but LEF support in Coriolis relies on SI2. If Coriolis hasn't been compiled against it, the library is given in ALLIANCE .ap format. **Some free libraries** already provide both .ap and .lib files.

Once you have installed a common library under Yosys and Coriolis, just synthesize your design with Yosys and import it (as Blif without the extension) under Coriolis to perform place&route.

Synthesis under Alliance ALLIANCE is an older toolchain but has been extensively used for years. Coriolis can import and write Alliance designs and libraries directly.

Etesian -- Placer

The ETESIAN placer is a state of the art (as of 2015) analytical placer. It is within 5% of other placers' solutions, but is normally a bit worse than ePlace. This COROLIS tool is actually an encapsulation of COLOQUINTE which is the placer.



Note

Instance Uniquification Unsupported: a same logical instance cannot have two different placements. So, either you manually make a clone of it or you supply a placement for it. We need to implement uniquification in the HURRICANE database.

Hierarchical Placement

The placement area is defined by the top cell abutment box.

When placing a complete hierarchy, the abutment boxes of the cells (models) other than the top cell are sets identical to the one of the top cell and their instances are all placed at position (0, 0, ID). That is, all the abutments boxes, whatever the hierarchical level, defines the same area (they are exactly superposed).

We choose this scheme because the placer will see all the instances as virtually flattened, so they can be placed anywhere inside the top-cell abutment box.

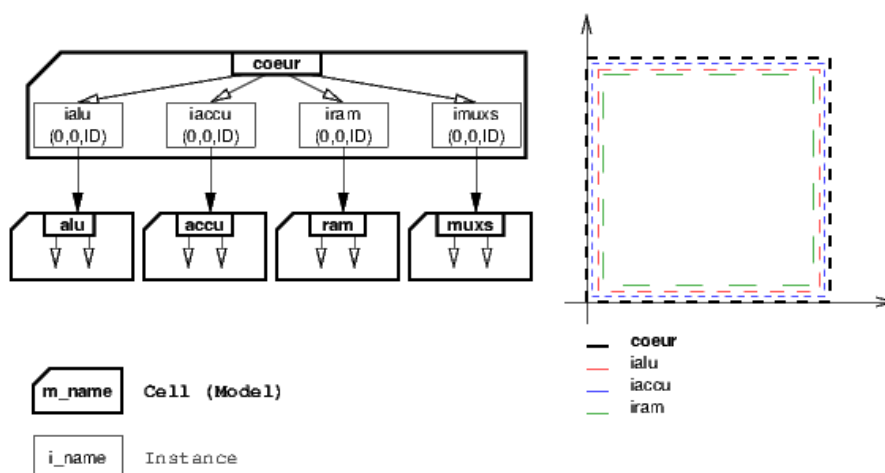

Computing the Placement Area

The placement area is computed using the `etesian.aspectRatio` and `etesian.spaceMargin` parameters only if the top-cell has an empty abutment box. If the top-cell abutment box has to be set, then it is propagated to all the instances models recursively.

Resetting the Placement

Once a placement has been done, the placer cannot reset it (will be implemented later). To perform a new placement, you must restart `cgt`. In addition, if you have saved the placement on disk, you must erase any `.ap` file, which are automatically reloaded along with the netlist (`.vst`).

Limitations

Etesian supports standard cells and fixed macros. As for the Coriolis 2.1 version, it doesn't support movable macros, and you must place every macro beforehand. Timing and routability analysis are not included either, and the returned placement may be unroutable.

Etesian Configuration Parameters

Parameter Identifier	Type	Default
Etesian Parameters		
<code>etesian.aspectRatio</code>	TypePercentage	100
	Define the height on width H/W aspect ratio, can be comprised between 10 and 1000	
<code>etesian.spaceMargin</code>	TypePercentage	5
	The extra white space added to the total area of the standard cells	
<code>etesian.uniformDensity</code>	TypeBool	False
	Whether the cells will be spread evenly across the area or allowed to form denser clusters	
<code>etesian.effort</code>	TypeInt	2
	Sets the balance between the speed of the placer and the solution quality	
<code>etesian.routingDriven</code>	TypeBool	False
	Whether the tool will try routing iterations and whitespace allocation to improve routability; to be implemented	
<code>etesian.graphics</code>	TypeInt	2
	How often the display will be refreshed More refreshing slows the placer. <ul style="list-style-type: none"> • 1 shows both upper and lower bounds • 2 only shows lower bound results • 3 only shows the final results 	

Knik -- Global Router

The quality of KNİK global routing solutions are equivalent to those of FGR 1.0. For an in-depth description of KNİK algorithms, you may download the thesis of D. DUPUIS available from here-: [Knik Thesis](#).

The global router is (not yet) deterministic. To circumvent this limitation, a global routing *solution* can be saved to disk and reloaded for later uses.

A global routing is saved into a file with the same name as the design and a **kgz** extension. It is in **Box Router** output format.

Menus:

- **P&R** → **Step by Step** → **Save Global Routing**
- **P&R** → **Step by Step** → **Load Global Routing**

Kite -- Detailed Router

KITE no longer suffers from the limitations of NERO . It can route big designs as its runtime and memory footprint is almost linear (with respect to the number of gates). It has successfully routed design of more than 150K gates.

However, this first release comes with the temporary the following restrictions:

- Works only with SxLIB standard cell gauge.
- Works always with 4 routing metal layers (*M2* through *M5*).
- Do not allow (take into account) pre-routed wires on signals other than POWER or GROUND



Note

Slow Layer Assignment. Most of the time, the layer assignment stage is fast (less than a dozen seconds), but in some instances it can take more than a dozen *minutes*. This is a known bug and will be corrected in later releases.

After each run, KITE displays a set of *completion ratios* which must all be equal to 100% if the detailed routing has been successful. In the event of a failure, on a saturated design, you may decrease the *edge saturation ratio* (argument *--edge*) to balance more evenly the design saturation. That is, the maximum saturation decrease at the price of a wider saturated area and increased wirelength. This is the saturation of the *global* router KNİK , and you may increase/decrease by steps of 5%, which represent one track. The maximum capacity of the SxLIB gauge is 10 tracks in two layers, that makes 20 tracks by KNİK edge.

Routing a design is done in four ordered steps:

1. Detailed pre-route **P&R** → **Step by Step** → **Detailed PreRoute**
2. Global routing **P&R** → **Step by Step** → **Global Route**
3. Detailed routing **P&R** → **Step by Step** → **Detailed Route**
4. Finalize routing **P&R** → **Step by Step** → **Finalize Route**

It is possible to supply to the router a complete wiring for some nets that the user's wants to be routed according to a specific topology. The supplied topology must respect the building rules of the KATABATIC database (contacts must be, terminals, turns, h-tee & v-tee only). During the first step `Detailed Pre-Route` the router will solve overlaps between the segments, without making any dogleg. If no pre-routed topologies are present, this step may be omitted. Any net routed at this step is then fixed and become unmovable for the later stages.

After the detailed routing step the KITE data-structure is still active (the Hurricane wiring is decorated). The finalize step performs the removal of the KITE data-structure, and it is not advisable to save the design before that step.

You may visualize the density (saturation) of either KNİK (on edges) or KITE (on GCells) until the routing is finalized. Special layers appears to that effect in the [The Layers&Go Tab](#).

Kite Configuration Parameters As KNIK is only called through KITE, its parameters also have the `kite.` prefix.

The KATABATIC parameters control the layer assignment step.

All the defaults value given below are from the default ALLIANCE technology (`cmos` and `SxLib` cell gauge/routing gauge).

Parameter Identifier	Type	Default
Katabatic Parameters		
<code>katabatic.topRoutingLayer</code>	TypeString	METAL5
	Define the highest metal layer that will be used for routing (inclusive).	
<code>katabatic.globalLengthThreshold</code>	TypeInt	1450
	This parameter is used by a layer assignment method which is no longer used (did not give good results)	
<code>katabatic.saturateRatio</code>	TypePercentage	80
	If $M(x)$ density is above this ratio, move up feedthru global segments up from depth x to $x+2$	
<code>katabatic.saturateRp</code>	TypeInt	8
	If a GCell contains more terminals (RoutingPad) than that number, force a move up of the connecting segments to those in excess	
Knik Parameters		
<code>kite.hTracksReservedLocal</code>	TypeInt	3
	To take account the tracks needed <i>inside</i> a GCell to build the <i>local</i> routing, decrease the capacity of the edges of the global router. Horizontal and vertical locally reserved capacity can be distinguished for more accuracy.	
<code>kite.vTracksReservedLocal</code>	TypeInt	3
	cf. <code>kite.hTracksReservedLocal</code>	
Kite Parameters		
<code>kite.eventsLimit</code>	TypeInt	400002
	The maximum number of segment displacements, this is a last ditch safety against infinite loop. It's perhaps a little too low for big designs	
<code>kite.ripupCost</code>	TypeInt	3
	Differential introduced between two ripup cost to avoid a loop between two ripped up segments	
<code>kite.strapRipupLimit</code>	TypeInt	16
	Maximum number of ripup for <i>strap</i> segments	
<code>kite.localRipupLimit</code>	TypeInt	9
	Maximum number of ripup for <i>local</i> segments	

... continued on next page

Parameter Identifier	Type	Default
kite.globalRipupLimit	TypeInt	5
	Maximum number of ripup for <i>global</i> segments, when this limit is reached, triggers topologic modification	
kite.longGlobalRipupLimit	TypeInt	5
	Maximum number of ripup for <i>long global</i> segments, when this limit is reached, triggers topological modification	

Executing Python Scripts in Cgt

Python/Stratus scripts can be executed either in text or graphical mode.



Note

How Cgt Locates Python Scripts: `cgt` uses the Python `import` mechanism to load Python scripts. So you must give the name of your script whitout `.py` extension and it must be reachable through the `PYTHONPATH`. You may uses the dotted module notation.

A Python/Stratus script must contains a function called `ScriptMain()` with one optional argument, the graphical editor into which it may be running (will be set to `None` in text mode). The Python interface to the editor (type: **CellViewer**) is limited to basic capabilities only.

Any script given on the command line will be run immediatly *after* the initializations and *before* any other argument is processed.

For more explanation on Python scripts see [Python Interface to Coriolis](#).

Printing & Snapshots

Printing or saving into a PDF is fairly simple, just uses the **File -> Print** menu or the `CTRL+P` shortcut to open the dialog box.

The print functionality uses exactly the same rendering mechanism as for the screen, beeing almost *WYSIWYG*. Thus, to obtain the best results it is advisable to select the `Coriolis.Printer` look (in the *Controller*), which uses a white background and much suited for high resolutions 32x32 pixels patterns

There is also two mode of printing selectable through the *Controller Settings -> Misc -> Printer/Snapshot Mode*:

Mode	DPI (approx.)	Intended Usage
Cell Mode	150	For single <code>Cell</code> printing or very small designs. Patterns will be bigger and more readable.
Design Mode	300	For designs (mostly commposed of wires and cells outlines).





Note

The pdf file size Be aware that the generated PDF files are indeed only pixmaps. So they can grew very large if you select paper format above `A2` or similar.

Saving into an image is subject to the same remarks as for PDF .

Memento of Shortcuts in Graphic Mode

The main application binary is `cgt` .

Category	Keys	Action
Moves	<div style="border: 1px solid black; padding: 2px; display: inline-block; margin-bottom: 2px;">Up</div> , <div style="border: 1px solid black; padding: 2px; display: inline-block; margin-bottom: 2px;">Down</div> <div style="border: 1px solid black; padding: 2px; display: inline-block; margin-bottom: 2px;">Left</div> , <div style="border: 1px solid black; padding: 2px; display: inline-block; margin-bottom: 2px;">Right</div>	Shift the view in the according direction
Fit	<div style="border: 1px solid black; padding: 2px; display: inline-block;">f</div>	Fit to the Cell abutment box
Refresh	<div style="border: 1px solid black; padding: 2px; display: inline-block;">CTRL+L</div>	Triggers a complete display redraw
Goto	<div style="border: 1px solid black; padding: 2px; display: inline-block;">g</div>	<i>aperture</i> is the minimum side of the area displayed around the point to go to. It's an alternative way of setting the zoom level
Zoom	<div style="border: 1px solid black; padding: 2px; display: inline-block;">z</div> , <div style="border: 1px solid black; padding: 2px; display: inline-block;">m</div>	Respectively zoom by a 2 factor and <i>unzoom</i> by a 2 factor
	 Area Zoom	You can perform a zoom to an area. Define the zoom area by <i>holding down the left mouse button</i> while moving the mouse.
Selection	 Area Selection	You can select displayed objects under an area. Define the selection area by <i>holding down the right mouse button</i> while moving the mouse.
	 Toggle Selection	You can toggle the selection of one object under the mouse position by pressing <div style="border: 1px solid black; padding: 2px; display: inline-block;">CTRL</div> and pressing down <i>the right mouse button</i> . A popup list of what's under the position shows up into which you can toggle the selection state of one item.
	<div style="border: 1px solid black; padding: 2px; display: inline-block;">S</div>	Toggle the selection visibility
Controller	<div style="border: 1px solid black; padding: 2px; display: inline-block;">CTRL+I</div>	Show/hide the controller window. It's the Swiss Army Knife of the viewer. From it, you can fine-control the display and inspect almost everything in your design.
Rulers	<div style="border: 1px solid black; padding: 2px; display: inline-block;">k</div> , <div style="border: 1px solid black; padding: 2px; display: inline-block;">ESC</div>	One stroke on <div style="border: 1px solid black; padding: 2px; display: inline-block;">k</div> enters the ruler mode, in which you can draw one ruler. You can exit the ruler mode by pressing <div style="border: 1px solid black; padding: 2px; display: inline-block;">ESC</div> . Once in ruler mode, the first click on the <i>left mouse button</i> sets the ruler's starting point and the second click the ruler's end point. The second click exits automatically the ruler mode.
	<div style="border: 1px solid black; padding: 2px; display: inline-block;">K</div>	Clears all the drawn rulers
Print	<div style="border: 1px solid black; padding: 2px; display: inline-block;">CTRL+P</div>	Currently rather crude. It's a direct copy of what's displayed in pixels. So the resulting picture will be a little blurred due to anti-aliasing mechanism.
Open/Close	<div style="border: 1px solid black; padding: 2px; display: inline-block;">CTRL+O</div>	Opens a new design. The design name must be given without path or extension.

... continued on next page

Category	Keys	Action
	CTRL+W	Close the current viewer window, but do not quit the application.
	CTRL+Q	CTRL+Q quit the application (closing all windows).
Hierarchy	CTRL+Down	Go one hierarchy level down. That is, if there is an <i>instance</i> under the cursor position, load it's <i>model</i> Cell in place of the current one.
	CTRL+Up	Go one hierarchy level up. if we have entered the current model through CTRL+Down reload the previous model (the one in which this model is instanciated).

Cgt Command Line Options

Appart from the obvious `--text` options, all can be used for text and graphical mode.

Arguments	Meaning
<code>-t --text</code>	Instruct cgt to run in text mode.
<code>-L --log-mode</code>	Disable the uses of ANSI escape sequence on the TTY . Useful when the output is redirected to a file.
<code>-c <cell> --cell=<cell></code>	The name of the design to load, without leading path or extention.
<code>-g --load-global</code>	Reload a global routing solution from disk. The file containing the solution must be named <code><cell>.kgr</code> .
<code>--save-global</code>	Save the global routing solution, into a file named <code><design>.kgr</code> .
<code>-e <ratio> --edge=<ratio></code>	Change the edge capacity for the global router, between 0 and 1 (KNIK).
<code>-G --global-route</code>	Run the global router (KNIK).
<code>-R --detailed-route</code>	Run the detailed router (KITE).
<code>-s --save-design=<routed></code>	The design into which the routed layout will be saved. It is strongly recommended to choose a different name from the source (unrouted) design.
<code>--events-limit=<count></code>	The maximal number of events after which the router will stops. This is mainly a failsafe against looping. The limit is sets to 4 millions of iteration which should suffice to any design of 100K. gates. For bigger designs you may wants to increase this limit.
<code>--stratus-script=<module></code>	Run the Python/Stratus script <code>module</code> . See Python Scripts in Cgt .

Some Examples :

- Run both global and detailed router, then save the routed design :

```
> cgt -v -t -G -R --cell=design --save-design=design_kite
```

- Load a previous global solution, run the detailed router, then save the routed design :

```
> cgt -v -t --load-global -R --cell=design --save-design=design_kite
```

- Run the global router, then save the global routing solution :

```
> cgt -v -t -G --save-global --cell=design
```

Miscellaneous Settings

Parameter Identifier	Type	Default
Verbosity/Log Parameters		
misc.info	TypeBool	False
	Enable display of <i>info</i> level message (cinfo stream)	
misc.bug	TypeBool	False
	Enable display of <i>bug</i> level message (cbug stream), messages can be a little scary	
misc.logMode	TypeBool	False
	If enabled, assume that the output device is not a <code>tty</code> and suppress any escaped sequences	
misc.verboseLevel1	TypeBool	True
	First level of verbosity, disable level 2	
misc.verboseLevel2	TypeBool	False
	Second level of verbosity	
Development/Debug Parameters		
misc.minTraceLevel	TypeInt	0
misc.maxTraceLevel	TypeInt	0
	Display trace information <i>between</i> those two levels (cdebug stream)	
misc.catchCore	TypeBool	False
	By default, cgt do not dump core. To generate one set this flag to True	

The Controller

The *Controller* window is composed of seven tabs:

1. **The Look Tab** to select the display style.
2. **The Filter Tab** the hierarchical levels to be displayed, the look of rubbers and the dimension units.
3. **The Layers&Go Tab** to selectively hide/display layers.
4. **The Netlist Tab** to browse through the *netlist*. Works in association with the *Selection* tab.
5. **The Selection Tab** allow to view all the currently selected elements.
6. **The Inspector Tab** browse through either the DataBase, the Cell or the current selection.
7. **The Settings Tab** access all the tool's configuration settings.

The Look Tab

You can select how the layout will be displayed. There is a special one `Printer.Coriolis` specifically designed for **Printing & Snapshots**. You should select it prior to calling the print or snapshot dialog boxes.

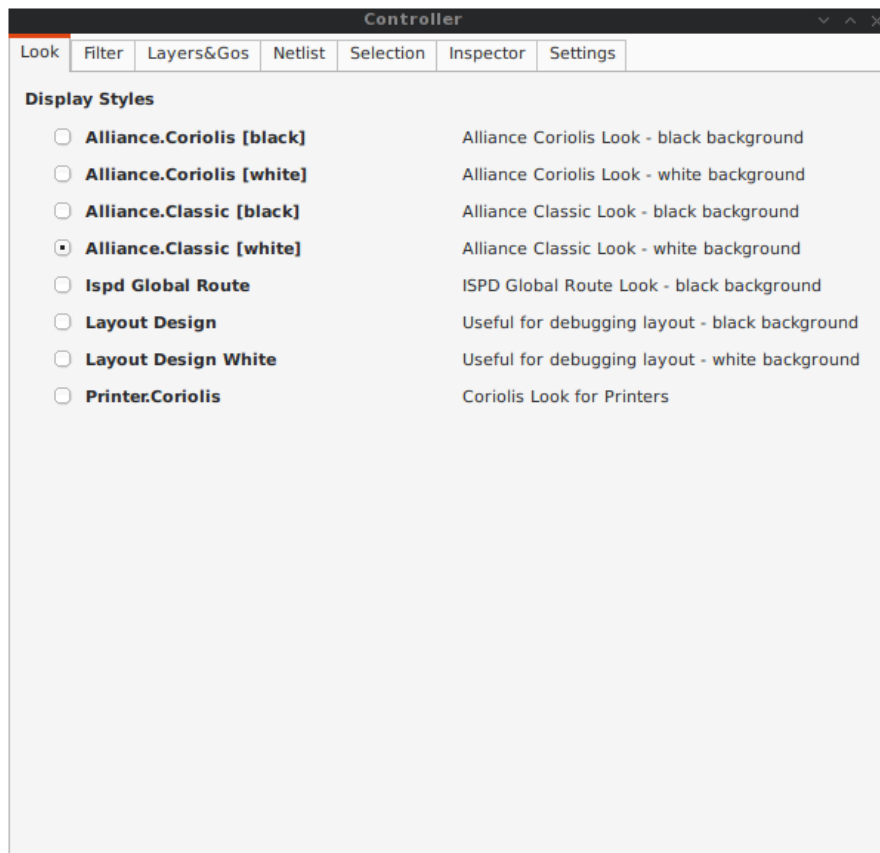

The Filter Tab

The filter tab let you select what hierarchical levels of your design will be displayed. Hierarchy level are numbered top-down: the level 0 correspond to the top-level cell, the level one to the instances of the top-level Cell and so on.

There are also check boxes to enable/disable the processing of Terminal Cell, Master Cells and Components. The processing of Terminal Cell (hierarchy leaf cells) is disabled by default when you load a hierarchical design and enabled when you load a single Cell.

You can choose what kind of form to give to the rubbers and the type of unit used to display coordinates.



Note

What are Rubbers: HURRICANE uses *Rubbers* to materialize physical gaps in net topology. That is, if some wires are missing to connect two or more parts of net, a *rubber* will be drawn between them to signal the gap.

For example, after the detailed routing no *rubbers* should remains. They have been made very visibles as big violet lines...

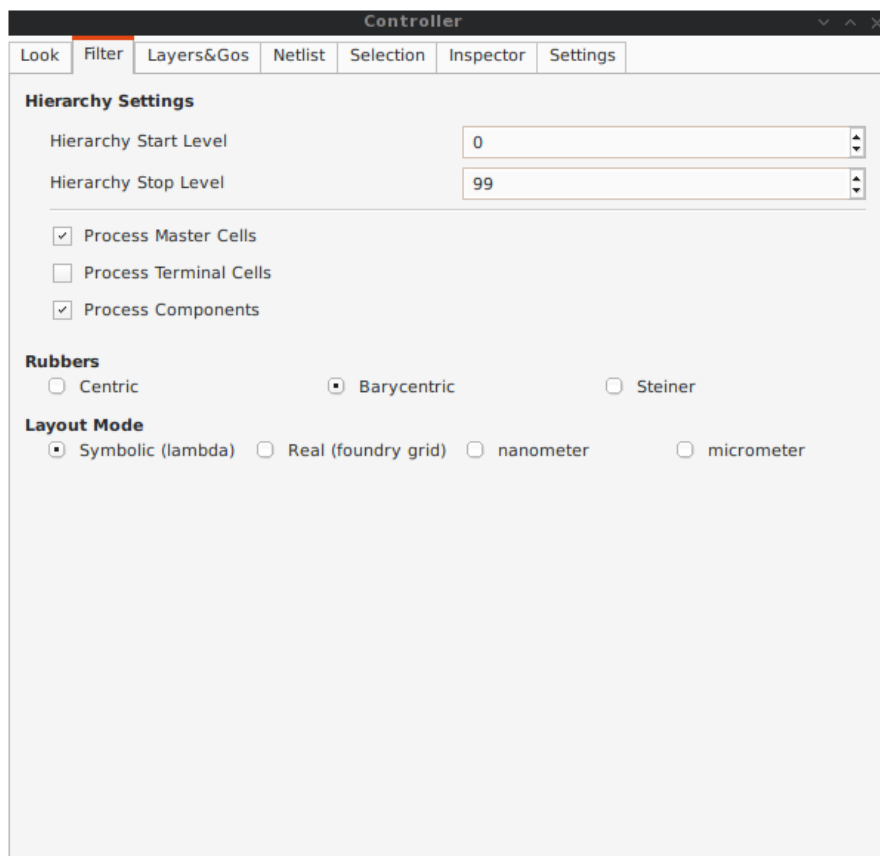

The Layers&Go Tab

Control the individual display of all *layers* and *Gos*.

- *Layers* correspond to a true physical layer. From a HURRICANE point of view they are all the *BasicLayers* (could be matched to GDSII).
- *Gos* stands from *Graphical Objects*, they are drawings that have no physical existence but are added by the various tools to display extra information. One good example is the density map of the detailed router, to easily locate congested areas.

For each layer/Go there are two check boxes:

- The normal one triggers the display.
- The red-outlined allows objects of that layer to be selectable or not.

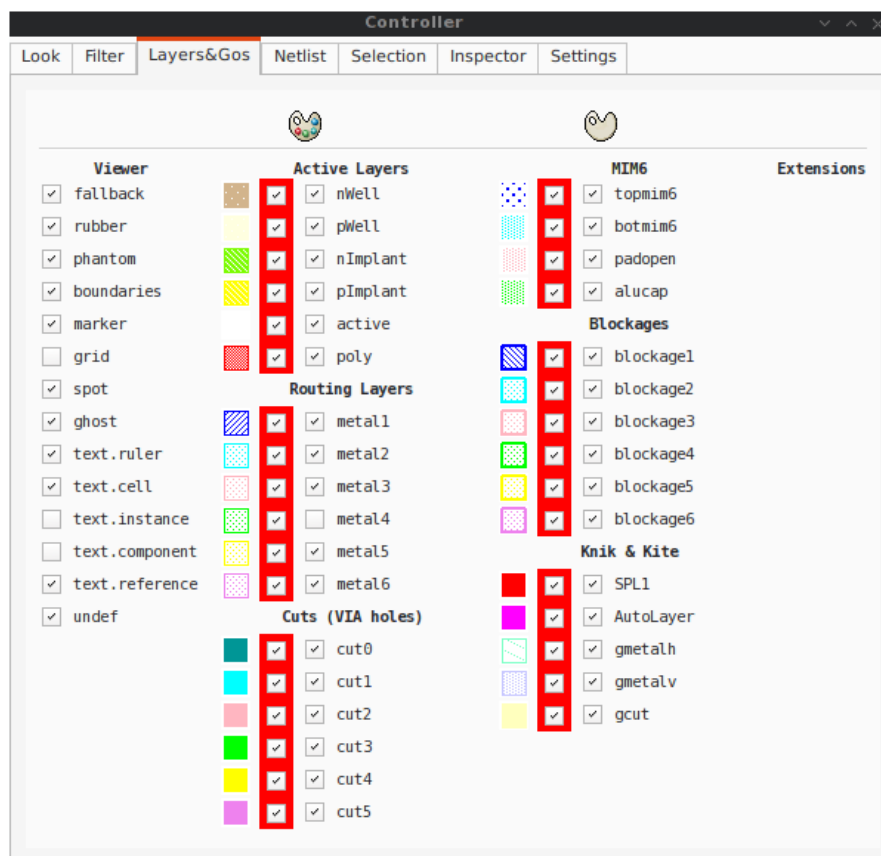

The Netlist Tab

The *Netlist* tab shows the list of nets... By default the tab is not *synced* with the displayed Cell. To see the nets you must check the **Sync Netlist** checkbox. You can narrow the set of displayed nets by using the filter pattern (supports regular expressions).

An very useful feature is to enable the **Sync Selection**, which will automatically select all the components of the selected net(s). You can select multiple nets. In the figure the net `auxsc35` is selected and is highlighted in the *Viewer*.

Controller

Look Filter Layers&Gos **Netlist** Selection Inspector Settings

Sync Netlist Sync Selection

Net	Plugs
a(0)	2
a(1)	1
a(2)	1
a(3)	1
auxreg1	2
auxreg2	2
auxreg3	3
auxreg4	4
auxsc1	8
auxsc11	2
auxsc16	3
auxsc18	3
auxsc20	4
auxsc21	4
auxsc22	4
auxsc24	3
auxsc35	3
auxsc36	2
auxsc37	2
auxsc38	2
auxsc39	5
auxsc40	2
auxsc41	4
auxsc43	2
auxsc44	2
auxsc45	2

Filter pattern:

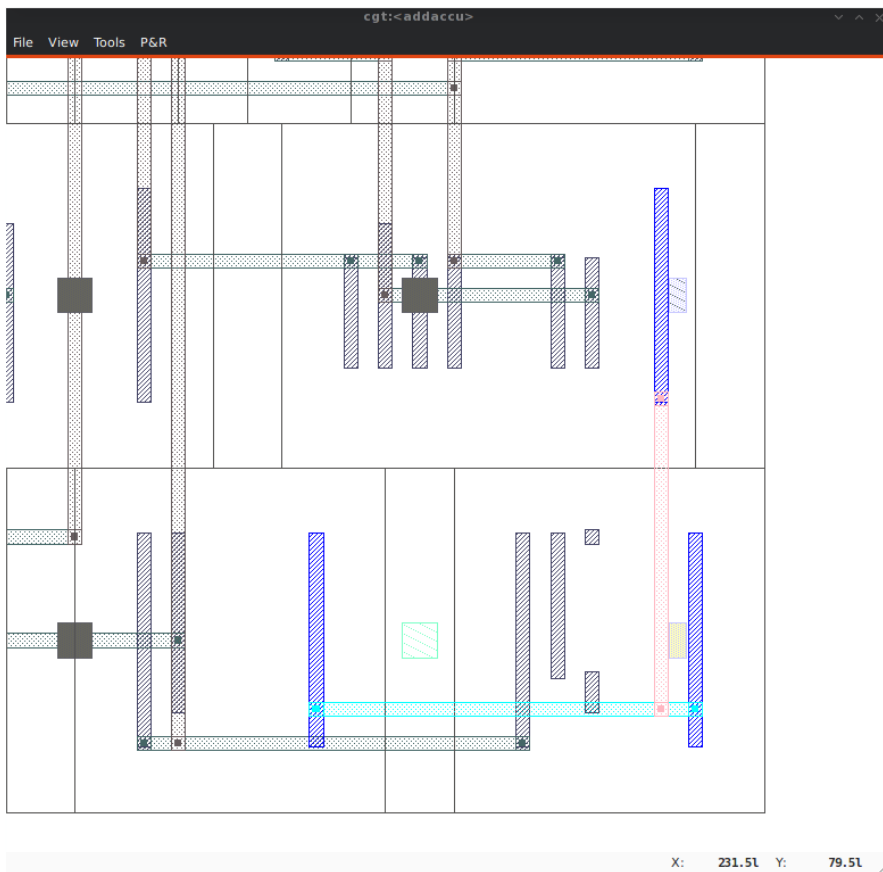

The Selection Tab

The *Selection* tab list all the components currently selecteds. They can be filtered thanks to the filter pattern.

Used in conjunction with the *Netlist Sync Selection* you will all see all the components part of *net*.

In this list, you can toggle individually the selection of component by pressing the `t` key. When unselected in this way a component is not removed from the the selection list but instead displayed in red italic. To see where a component is you may make it blink by repeatedly press the `t` key...

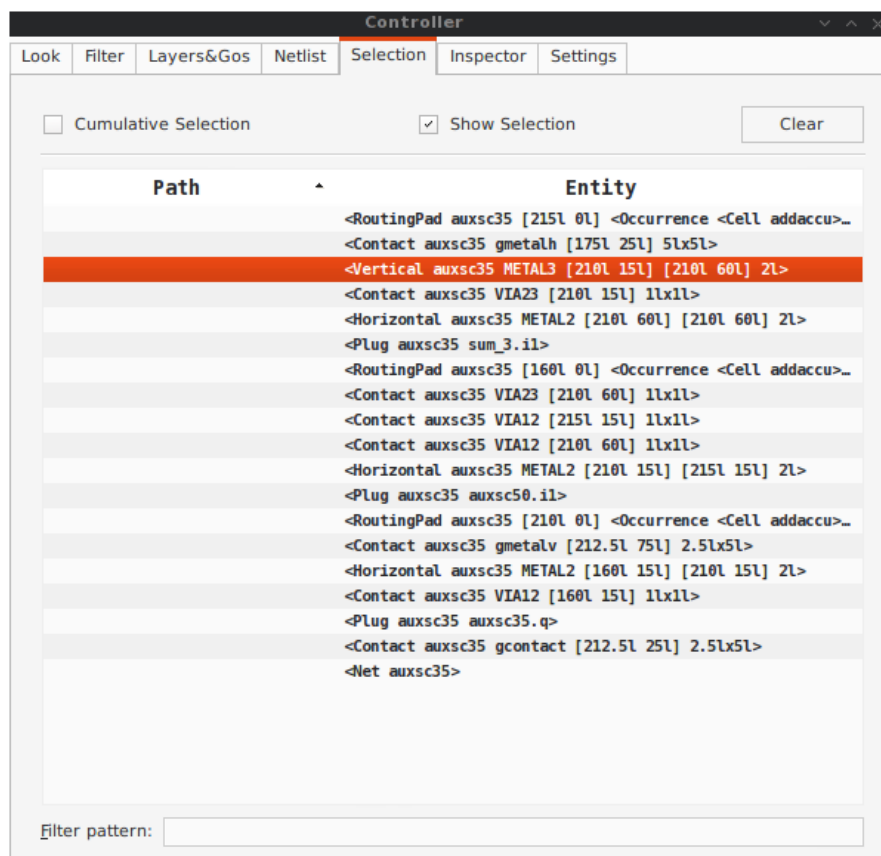

The Inspector Tab

This tab is very useful, but mostly for CORIOLIS developpers. It allows to browse through the live DataBase. The *Inspector* provide three entry points:

- **DataBase:** Starts from the whole HURRICANE DataBase.
- **Cell:** Inspect the currently loaded Cell.
- **Selection:** Inspect the object currently highlighted in the *Selection* tab.

Once an entry point has been activated, you may recursively explore all it's fields using the right/left arrows.



Note

Do not put your fingers in the socket: when inspecting anything, do not modify the DataBase. If any object under inspection is deleted, you will crash the application...

**Note**

Implementation Detail: the inspector support is done with Slot, Record and getString().

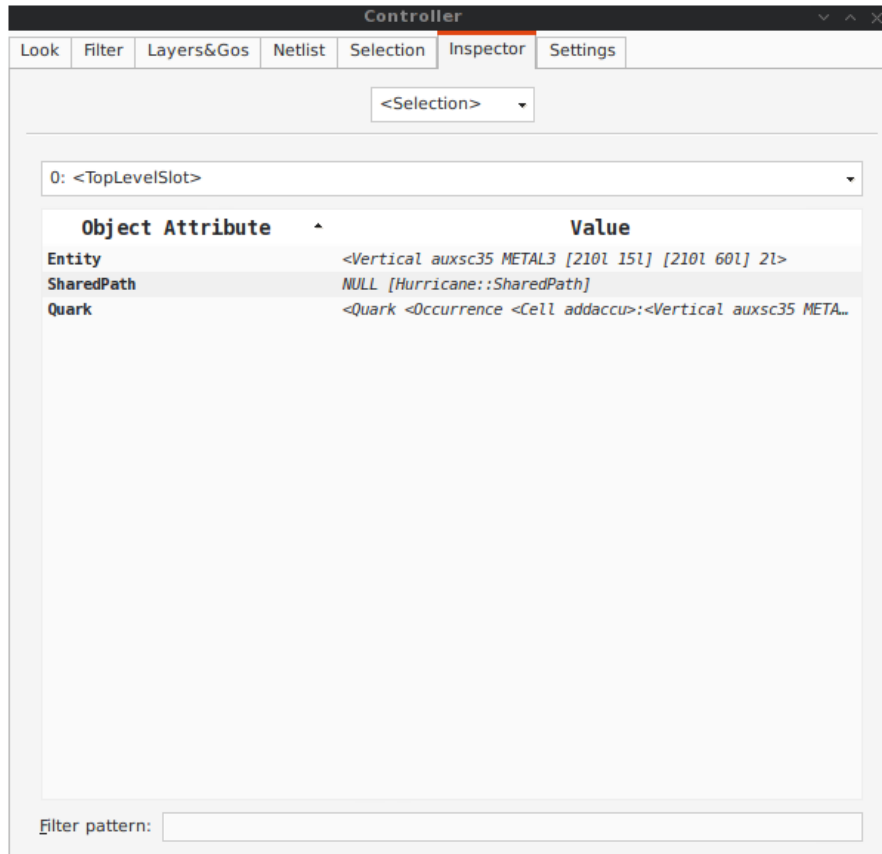

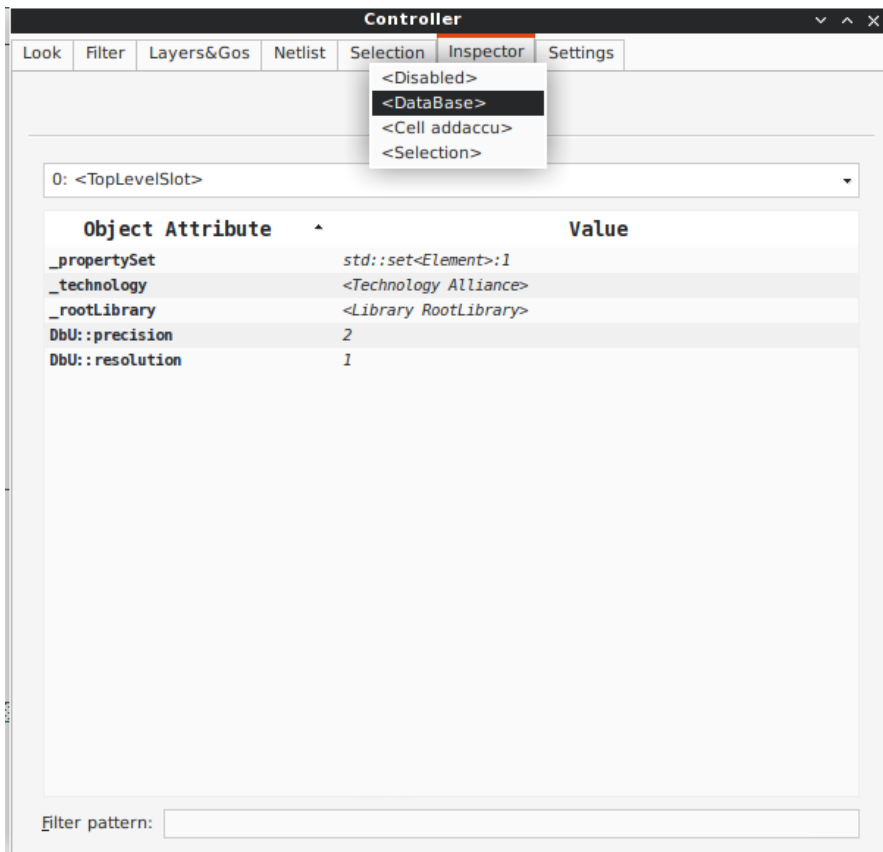
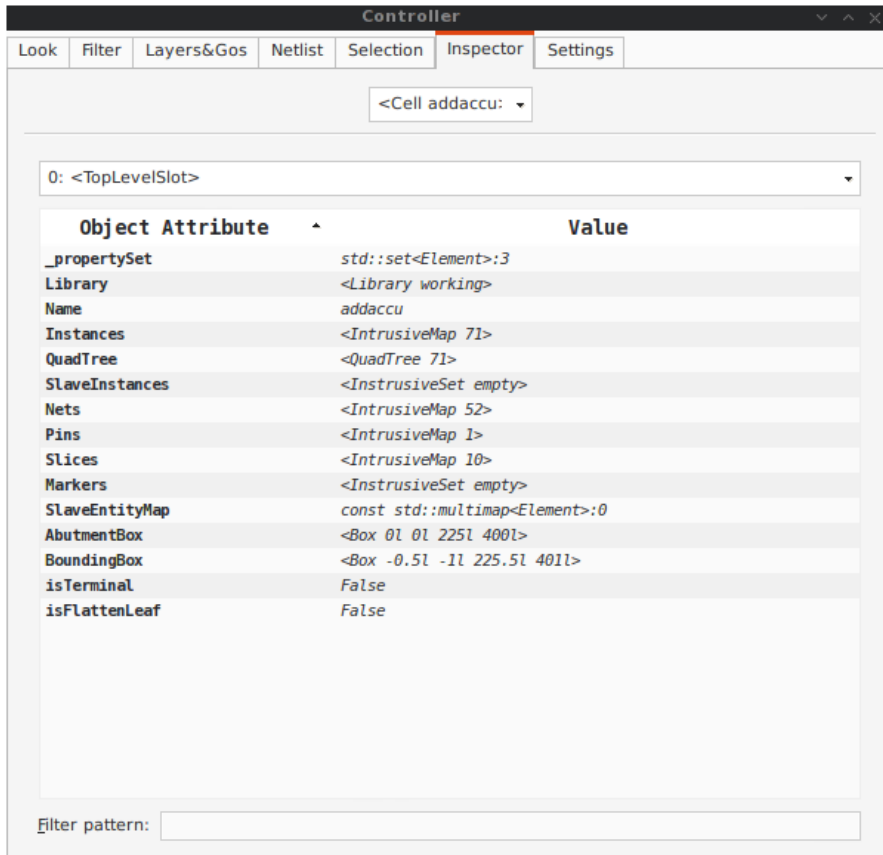

The Settings Tab

Here comes the description of the *Settings* tab.

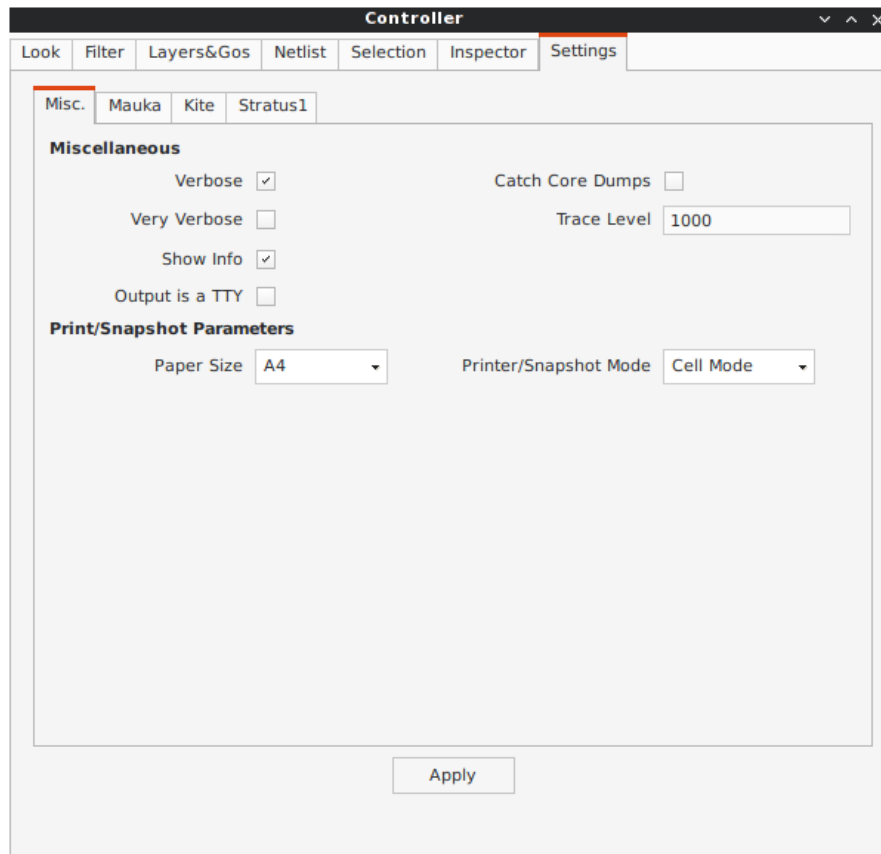

Python Interface for HURRICANE / CORIOLIS

The (almost) complete interface of HURRICANE is exported as a PYTHON module and some part of the other components of CORIOLIS (each one in a separate module). The interface has been made to mirror as closely as possible the C++ one, so the C++ doxygen documentation could be used to write code with either languages.

Summary of the C++ Documentation

A script could be run directly in text mode from the command line or through the graphical interface (see [Python Scripts in Cgt](#)).

Asides for this requirement, the python script can contain anything valid in PYTHON , so don't hesitate to use any package or extension.

Small example of Python/Stratus script:

```
from Hurricane import *
from Stratus import *

def doSomething ():
    # ...
    return

def ScriptMain ( **kw ):
    editor = None
    if kw.has_key('editor') and kw['editor']:
        editor = kw['editor']
        stratus.setEditor( editor )
```



```

doSomething()
return

if __name__ == "__main__" :
    kw          = {}
    success     = ScriptMain( **kw )
    shellSuccess = 0
    if not success: shellSuccess = 1

    sys.exit( shellSuccess )
        ScriptMain ()

```

This typical script can be executed in two ways:

1. Run directly as a PYTHON script, thanks to the

```
if __name__ == "__main__" :
```

part (this is standart PYTHON). It is a simple adapter that will calls **ScriptMain()** .

2. Through **cgt** , either in text or graphical mode. In that case, the **ScriptMain()** is directly called trough a sub-interpreter. The arguments of the script are passed through the ****kw** dictionary.

**kw Dictionary	
Parameter Key/Name	Contents type
'cell'	A Hurricane cell on which to work. Depending on the context, it may be None. For example, when run from cgt , it the cell currently loaded in the viewer, if any.
'editor'	The viewer from which the script is run, when lauched through cgt .

Plugins

Plugins are PYTHON scripts specially crafted to integrate with **cgt** . Their entry point is a **ScriptMain()** method as described in [Python Interface to Coriolis](#). They can be called by user scripts through this method.

Chip Placement

Automatically perform the placement of a complete chip. This plugin, as well as the other P&R tools expect a specific top-level hierarchy for the design. The top-level hierarchy must contains the instances of all the I/O pads and **exactly one** instance of the chip's core model.

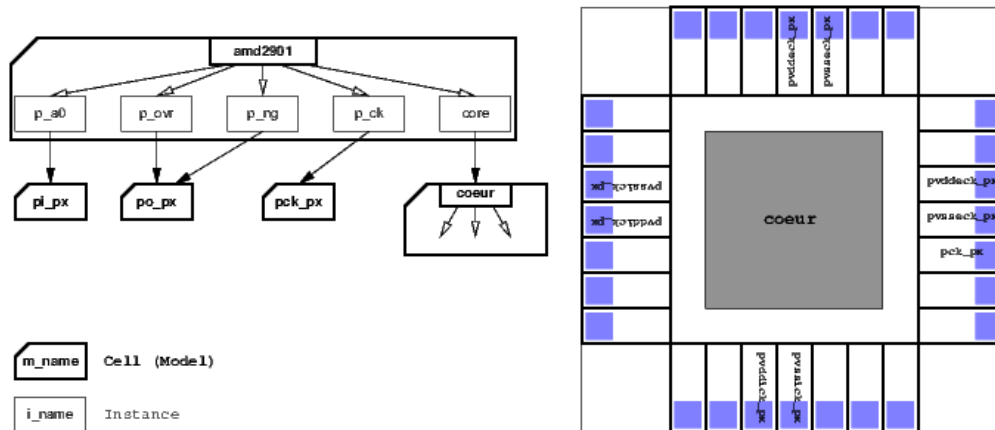

The designer must provide a configuration file that define the rules for the placement of the top-level hierarchy (that is, the pads and the core). This file must be named after the chip's name, by appending `_chip.py` (obviously, it is a PYTHON file). For instance if the chip netlist file is called `amd2901_crl.vst`, then the configuration file must be named `amd2901_crl_chip.vst`.

Example of chip placement configuration file (for AM2901):

```

chip = \
  { 'pads.south'      : [ 'p_a3'      , 'p_a2'      , 'p_a1'      , 'p_r0'
                        , 'p_vddick0', 'p_vssick0', 'p_a0'      , 'p_i6'
                        , 'p_i8'      , 'p_i7'      , 'p_r3'      ]
    , 'pads.east'     : [ 'p_zero'    , 'p_i0'      , 'p_i1'      , 'p_i2'
                        , 'p_vddeck0', 'p_vsseck0', 'p_q3'      , 'p_b0'
                        , 'p_b1'      , 'p_b2'      , 'p_b3'      ]
    , 'pads.north'    : [ 'p_noe'     , 'p_y3'      , 'p_y2'      , 'p_y1'
                        , 'p_y0'      , 'p_vddeck1', 'p_vsseck1', 'p_np'
                        , 'p_ovr'     , 'p_cout'     , 'p_ng'      ]
    , 'pads.west'     : [ 'p_cin'     , 'p_i4'      , 'p_i5'      , 'p_i3'
                        , 'p_ck'      , 'p_d0'      , 'p_d1'      , 'p_d2'
                        , 'p_d3'      , 'p_q0'      , 'p_f3'      ]
    , 'core.size'     : ( 1500, 1500 )
    , 'chip.size'     : ( 3000, 3000 )
    , 'chip.clockTree': True
  }
    
```

The file must contain *one dictionnary* named `chip`.

Chip Dictionnary	
Parameter Key/Name	Value/Contents type
'pad.south'	Ordered list (left to right) of pad instances names to put on the south side of the chip
'pad.east'	Ordered list (down to up) of pad instances names to put on the east side of the chip
'pad.north'	Ordered list (left to right) of pad instances names to put on the north side of the chip
'pad.west'	Ordered list (down to up) of pad instances names to put on the west side of the chip
'core.size'	The size of the core (to be used by the placer)
'chip.size'	The size of the whole chip. The sides must be great enough to accomodate all the pads

... continued on next page

Chip Dictionary	
Parameter Key/Name	Value/Contents type
'chip.clockTree'	Whether to generate a clock tree or not. This calls the ClockTree plugin

Configuration parameters, defaults are defined in `etc/coriolis2/<STECHNO>/plugins.conf`.

Parameter Identifier	Type	Default
Chip Plugin Parameters		
chip.block.rails.count	TypeInt	5
	The minimum number of rails around the core block. Must be odd and superior to 5. One rail for the clock and at least two pairs of power/grounds	
chip.block.rails.hWidth	TypeInt	12
	The horizontal with of the rails	
chip.block.rails.vWidth	TypeInt	12
	The vertical with of the rails	
chip.block.rails.hSpacing	TypeInt	6
	The spacing, <i>edge to edge</i> of two adjacent horizontal rails	
chip.block.rails.vSpacing	TypeInt	6
	The spacing, <i>edge to edge</i> of two adjacent vertical rails	
chip.pad.pck	TypeString	pck_px
	The model name of the pad connected to the chip external clock	
chip.pad.pvdeck	TypeString	pvddeck_px
	The model name of the pad connected to the <code>vdde</code> (external power) and supplying it to the core	
chip.pad.pvsseck	TypeString	pvsseck_px
	The model name of the pad connected to the <code>vsse</code> (external ground) and supplying it to the core	
chip.pad.pvddick	TypeString	pvddick_px
	The model name of the pad connected to the <code>vddi</code> (internal power) and supplying it to the core	
chip.pad.pvssick	TypeString	pvssick_px
	The model name of the pad connected to the <code>vssi</code> (internal ground) and supplying it to the core	



Note

If no clock tree is generated, then the clock rail is *not* created. So even if the requested number of rails `chip.block.rails.count` is, say 5, only four rails (2* power, 2* ground) will be generated.

Clock Tree

Insert a clock tree into a block. The clock tree uses the H strategy. The clock net is splitted into sub-nets, one for each branch of the tree.

- On **chips** design, the sub-nets are created in the model of the core block (then trans-hierarchically flattened to be shown at chip level).
- On **blocks**, the sub nets are created directly in the top block.
- The sub-nets are named according to a simple geometrical scheme. A common prefix `ck_htree`, then one postfix by level telling on which quarter of plane the sub-clock is located:
 1. `_bl`: bottom left plane quarter.
 2. `_br`: bottom right plane quarter.
 3. `_tl`: top left plane quarter.
 4. `_tr`: top right plane quarter.

We can have `ck_htree_bl`, `ck_htree_bl_bl`, `ck_htree_bl_tl` and so on.

The clock tree plugin works in four steps:

1. Build the clock tree: creates the top-block abutment box, compute the levels of H tree neededs and place the clock buffers.
2. Once the clock buffers are placed, calls the placer (ETESIAN) to place the ordinary standart cells, whitout disturbing clock H-tree buffers.
3. At this point we know the exact positions of all the DFFs, so we can connect them to the nearest H-tree leaf clock signal.
4. Leaf clock signals that are not connecteds to any DFFs are removed.

Netlist reorganisation:

- Obviously the top block or chip core model netlist is modiflicated to contains all the clock sub-nets. The interface is *not* changed.
- If the top block contains instances of other models *and* those models contains DFFs that get re-connecteds to the clock sub-nets (from the top level). Change both the model netlist and interface to propagate the relevant clock sub-nets to the instanciated model. The new model with the added clock signal is renamed with a `_clocked` suffix. For example, the sub-block model `ram.vst` will become `ram_clocked.vst`.



Note

If you are to re-run the clock tree plugin on a netlist, be careful to erase any previously generated `_clocked` file (both netlist and layout: `rm *.clocked.{ap,vst}`). And restart `cgt` to clear it's memory cache.

Configuration parameters, defaults are defined in `etc/coriolis2/<STECHNO>/plugins.conf`.

Parameter Identifier	Type	Default
ClockTree Plugin Parameters		
<code>clockTree.minimumSide</code>	TypeInt	300
	The minimum size below which the clock tree will stop to perform quadri-partitions	

... continued on next page

Parameter Identifier	Type	Default
clockTree.buffer	TypeString	buf_x2
	The buffer model to use to drive sub-nets	
clockTree.placerEngine	TypeString	Etesian
	The placer to use. Other value is Mauka the simulated annealing placer which will go into retirement very soon	

Recursive-Save (RSave)

Perform a recursive top down save of all the models from the top cell loaded in **cgf** . Force a write of any non-terminal model. This plugin is used by the clock tree plugin after the netlist clock sub-nets creation.

A Simple Example: AM2901

To illustrate the capabilities of CORIOLIS tools and PYTHON scripting, a small example, derived from the ALLIANCE **AM2901** is supplied.

This example contains only the synthesized netlists and the **doChip.py** script which perform the whole P&R of the design.

You can generate the chip using one of the following method:

1. **Command line mode:** directly run the script:

```
dummy@lepka:AM2901> ./doChip -V --cell=amd2901
```

2. **Graphic mode:** launch **cgf** , load chip netlist amd2901 (the top cell) then run the PYTHON script **doChip.py** .



Note

Between two consecutive run, be sure to erase the netlist/layout generateds:

```
dummy@lepka:AM2901> rm *clocked*.vst *.ap
```